

Model: A-162 Model: B-162

Thank You and congratulations on your choice of a genuine HAMMOND Organ.

The A-162 is a Console Organ featuring the traditional Drawbar sounds of a vintage Hammond Organ with "A-100" style cabinet which has an amplifier and speakers.

Please read this manual thoroughly before using your A-162 and refer to it as necessary.

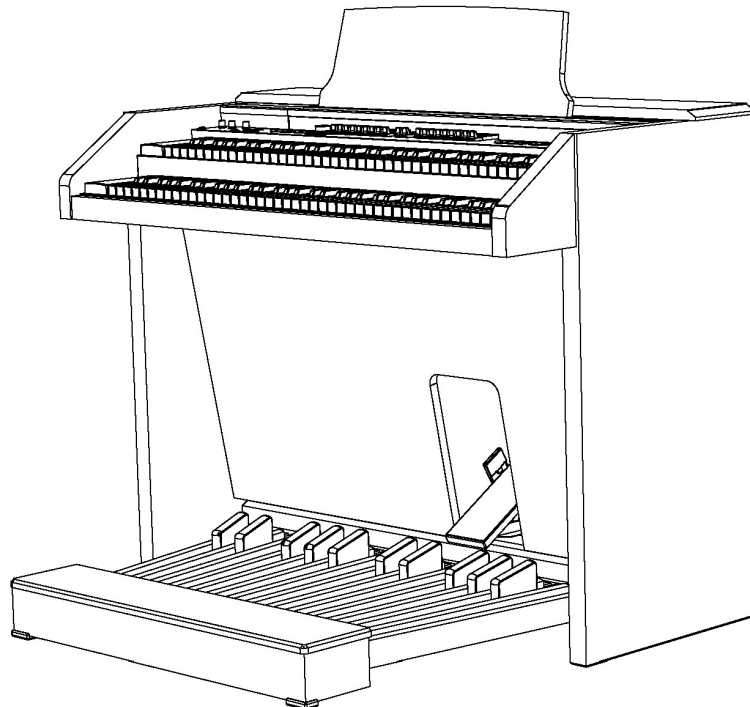

Owner's Manual

IMPORTANT SAFETY INSTRUCTIONS

Read these instructions.

Keep these instructions.

Heed all warnings.

Follow all instructions.

Do not use this apparatus near water.

Clean only with dry cloth.

Do not block any ventilation openings.

Install in accordance with the manufacturer's instructions.

Do not install near any heat sources such as radiators, heat registers, stoves or other apparatus (including amplifiers) that produce heat.

Do not defeat the safety purpose of the polarized or grounding-type plug. A polarized plug has two blades with one wider than the other. A grounding type plug has two blades and a third grounding prong. The wider blade or third prong is provided for your safety. If the provided plug does not fit into your outlet, consult an electrician for replacement of the obsolete outlet.

Protect the power cord from being walked on or pinched, particularly at plugs, convenience receptacles, and the point where they exit from the apparatus.

Only use attachments/accessories specified by the manufacturer.

Use only with the cart, stand, tripod, bracket, or table specified by the manufacturer, or sold with the apparatus. When cart is used: use caution when moving the cart/apparatus combination to avoid injury from tip-over.

PORTABLE CART WARNING



S3125A

Unplug this apparatus during lightning storms, or when unused for long periods of time.

Refer all servicing to qualified service personnel. Servicing is required when the apparatus has been damaged in any way, such as power-supply cord or plug is damaged, liquid has been spilled or objects have fallen into the apparatus, the apparatus has been exposed to rain or moisture, does not operate normally, or has been dropped.

Apparatus shall not be exposed to dripping or splashing and no objects filled with liquids, such as vases, shall be placed on the apparatus.

WARNING: To reduce the risk of fire or electric shock, do not expose this apparatus to rain or moisture.

ATTENTION: Pour réduire les risques de choc électrique ou d'incendie, ne pas exposer cet appareil à la pluie ou à l'humidité.



注意 : 感電の恐れあり キャビネットをあけるな
ATTENTION : RESQUE DE CHOC ELECTRIQUE NE PAS OUVRIR

WARNING :
TO REDUCE THE RISK OF FIRE OR ELECTRIC SHOCK,
DO NOT EXPOSE THIS APPLIANCE TO RAIN OR MOISTURE.

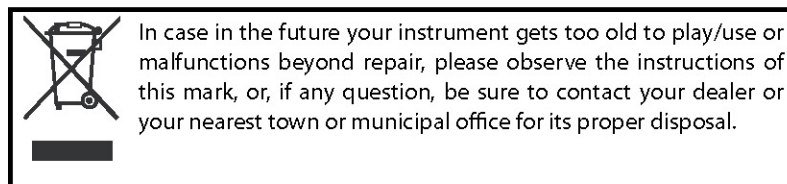
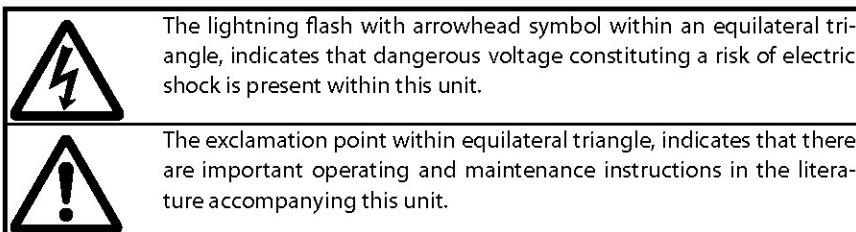

FOR UNITED KINGDOM:

FOR YOUR SAFETY, PLEASE READ THE FOLLOWING TEXT CAREFULLY

This appliance is supplied with a molded 3-pin mains plug for your safety and convenience.

The plug contains a 5 amp fuse.

Should the fuse need to be replaced, please ensure that the replacement fuse has a rating of 5 amps and that it is approved by ASTA or BSI to BSI 1362.

Check for the ASTA mark  or the BSI mark  on the body of the fuse.

If the plug contains a removable fuse cover, you must ensure that it is refitted when the fuse is replaced.

If the fuse cover is lost, the plug must not be used until a replacement cover is obtained.

A replacement fuse cover can be obtained from your local Hammond Dealer.

IF THE FITTED MOULDED PLUG IS UNSUITABLE FOR THE SOCKET OUTLET IN YOUR HOME, THEN THE FUSE SHOULD BE REMOVED AND THE PLUG CUT OFF AND DISPOSED OF SAFELY.

THERE IS A DANGER OF SEVERE ELECTRICAL SHOCK IF THE CUT-OFF PLUG IS INSERTED INTO ANY 13 AMP SOCKET.

If a new plug is to be attached to the cord, please observe the wiring code as shown below.

If in any doubt, please consult a qualified electrician.

IMPORTANT - The wires in this mains lead are coloured in accordance with the following code:

Blue:	Neutral
Brown:	Live

As the colours of the wires in the mains lead of this unit may not correspond with the coloured marking identifying the terminals in your plug, proceed as follows.

The wire which is coloured BLUE must be connected to the terminal in the plug which is marked with the letter N or coloured BLACK.

The wire which is coloured BROWN must be connected to the terminal in the plug which is marked with the letter L or coloured RED.

Under no circumstances should either of these wires be connected to the earth terminal of the three-pin plug, marked with the letter E or the Earth Symbol .

To replace the fuse, open the fuse compartment with a screwdriver and replace the fuse and fuse cover.

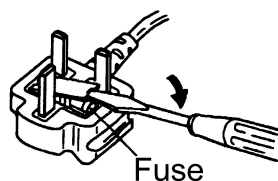

Your Hammond Organ A-162 is designed to give you the true and authentic sound of Hammond Harmonic Drawbars, as well as provide you a large variety of features to allow great flexibility in how you want to use the organ. This Owner's Manual is designed to explain the operating features of your Hammond A-162 as simply and graphically as possible.

Because we want to make this manual, as well as the organ itself, as easy to understand as possible, the explanations in this manual are grouped by subject matter, and not in the order in which they necessarily appear in the display (the screen under the lid). For example, all functions pertaining to Drawbars are grouped together, all Percussion features are treated as a group, and so on.

Also, each feature is treated as an explanation unto itself, and does not require you to already have prior working knowledge of some other feature. The explanations are presented such that, if you follow the steps, will be identical to that shown in the manual at that stage of the explanation.

Do not be daunted by the number of steps required to perform each operation. Each step is simple. Simply bear these things in mind:

1. Read each step carefully.
2. Don't skip any of the steps.
3. Don't perform the steps out of sequence.

With these guidelines, you are well on your way to mastering all of the many sounds and features of your Hammond A-162.

Your A-162 uses a battery-backed RAM to remember your changes to the Parameters. When the battery voltage becomes low, the Display will show:

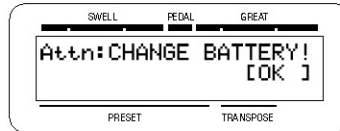
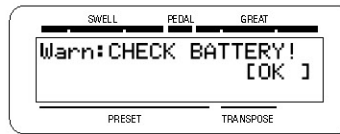

If you see these messages, you should immediately back up your parameter changes, if you have made any. If there is no battery installed in the unit, or if the battery is completely dead, the Display will show:

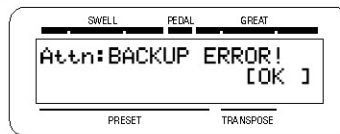

After the above message is displayed, the A-162 will re-initialize itself, and the factory default settings will be restored (except Presets, Leslie Cabinets and Custom Tone Wheels). Therefore, it is a good idea to periodically save your data to a CompactFlash™ card.

- ❖ **CAUTION:** Contact your Hammond Organ dealer for information on the correct battery to use.

Table Of Contents

IMPORTANT SAFETY INSTRUCTIONS.....	2	PEDAL Drawbars	35
IMPORTANT - PLEASE READ.....	4	Drawbar Registration Patterns.....	36
BATTERY BACK UP	5	◆ Flute family (2 step pattern).....	36
MAIN FEATURES	9	◆ Reed family (triangle pattern).....	36
HOW TO ASSEMBLE	10	◆ Diapason family (check mark pattern).....	36
Components.....	10	◆ String family (bow pattern).....	36
Connect the Pedalboard.....	11	Modern Drawbar Registrations	37
Bench	11	◆ Jazz.....	37
Put on the Music Rack.....	11	◆ Groovy & Funky.....	37
NAMES AND FUNCTIONS	12	◆ Bluesy	37
Top Panel	12	◆ Max Power	37
Upper Left.....	14	Match the Registration to Drawbars.....	38
Underside Of Manual	15	Controlling the Registration while playing a Preset.....	39
Rear Panel.....	15	PERCUSSION.....	40
Pedals.....	16	◆ "Percussion does not sound!".....	40
HOOK-UP	17	◆ Drawbar Cancel.....	40
BASIC HOOK-UP	18	VIBRATO AND CHORUS	41
CONNECTING THE LESLIE SPEAKER	18	LESLIE	42
USING A MIDI SOUND MODULE.....	19	OVERDRIVE.....	43
USING HEADPHONES.....	19	TONE	44
USING AN EXTERNAL FOOT SWITCH	20	REVERB, PEDAL SUSTAIN, COUPLER.....	45
USING A LESLIE CONTROL SWITCH.....	20	PRESETS	46
POWER ON AND PLAY.....	21	Bank and Key.....	46
POWER ON	22	Name the current setting.....	47
How to power on.....	22	Recording your own Presets.....	48
Switch-off memory	22	TRANPOSE	49
Reset to the factory settings.....	22	USING THE CONTROL PANEL.....	51
LISTEN TO THE DEMONSTRATION PERFORMANCE.....	23	USING THE CONTROL PANEL	52
USING THE COMBINATION PRESETS	24	PLAY MODE.....	53
How to recall the Preset	24	How to read the display	53
◆ Ex. Select C#-G.....	24	MENU MODE	54
USING THE CONTROLLERS	25	How to read the display	54
Expression Pedal	25	Button operation in this mode.....	54
Foot Switch	25	Menus and their contents.....	55
TRY MAKING YOUR OWN SOUND.....	26	FUNCTION MODE	56
Select the SWELL "B" Preset Key.....	26	How to read the display	56
Pull out the SWELL Drawbars	26	Button operation in this mode.....	56
Add Percussion	26	SHORT CUT TO THE FUNCTION MODE.....	57
Add effects.....	27	Example of operation:.....	57
◆ Vibrato and Chorus.....	27	Example of operation:.....	58
◆ Leslie	27	LOCK THE DISPLAY IN PLAY MODE.....	60
◆ Reverb.....	27	SETTING THE PARAMETERS	61
Pedal Sustain	28	DRAWBAR	62
Pedal To Great	28	◆ MANUAL DRAWBARS (SWELL and GREAT).....	62
Great To Pedal	28	◆ PEDAL DRAWBARS.....	63
Storing registrations to Presets.....	29	PRESET.....	64
◆ Ex. Memorize to "F - D" for GREAT part.....	29	◆ PRESET NAME	64
SETTING UP	31	◆ PRESET LOAD.....	64
SOUND ENGINE STRUCTURE	32	◆ PRESET BANK.....	65
HARMONIC DRAWBARS™	34	CONTROL	66
Manual Drawbars.....	35	◆ FOOT SWITCH	66
◆ White Drawbars	35	◆ EXPRESSION	67
◆ Black Drawbars.....	35	◆ GLIDE.....	67
◆ Brown Drawbars.....	35	◆ DAMPER.....	67
		◆ DISPLAY.....	68
		◆ DRAWBARS	68
		◆ COUPLER.....	68
		◆ KEYBOARD.....	68
		TUNE	69

CUST. TW (CUSTOm Tone Wheels).....	70	MIDI Implementation.....	110
Store the CUSTOM virtual tone wheels.....	72	◆ Channel Voice Message.....	110
PERCUSS (PERCUSSION).....	73	◆ Channel Mode Message.....	110
LESLIE.....	74	Drawbar Data List.....	111
◆ CABINET NUMBERS.....	74	System Exclusive Message.....	112
◆ LESLIE PARAMETERS.....	74	◆ NRPN Switch.....	112
◆ EXTERNAL LESLIE SPEAKER.....	76	◆ Data Set (Rx. only).....	112
Store the Cabinets.....	77	◆ Identity Request (Rx. only).....	112
OD/VIB (OverDrive / VIBrato).....	78	◆ Identity Reply (Tx. only).....	112
◆ OVERDRIVE.....	78	Global Parameters.....	113
◆ VIBRATO & CHORUS.....	78	Bank Parameters.....	113
Vibrato and Chorus of Hammond Organs.....	79	Preset Parameters.....	114
EQUALIZ (EQUALIZER).....	80	Leslie Parameters.....	116
REVERB.....	81	System Parameters.....	116
DEFAULT.....	82	MIDI IMPLEMENTATION CHART.....	117
SYSTEM.....	83	FACTORY PRESETS.....	118
MIDI.....85		◆ Bank C "Jazz 1".....	118
ABOUT MIDI.....	86	◆ Bank C # "Jazz 2".....	118
What is "MIDI" ?.....	86	◆ Bank D "Gospel 1".....	118
MIDI terminals on this Organ.....	86	◆ Bank D # "Gospel 2".....	118
What the MIDI can do on your Organ.....	86	◆ Bank E "Theatre".....	118
MIDI STRUCTURE.....	88	◆ Bank F "Tibia".....	118
◆ KEYBOARD CHANNELS.....	88	◆ Bank F # "Church Organ".....	118
◆ EXTERNAL ZONE CHANNELS.....	88	◆ Bank G "Pop Organ".....	118
USING AN EXTERNAL SEQUENCER.....	89	◆ Bank G # "User Presets".....	119
◆ Recording to the Sequencer or the Computer.....	89	◆ Bank A "MIDI Presets".....	119
◆ Playback from the Sequencer or the Computer.....	89	◆ Bank A # "Hammond Theatre Presets".....	119
USING A MIDI COMPATIBLE LESLIE SPEAKER.....	90	◆ Bank B "Hammond Liturgical Presets".....	119
USING A MIDI SOUND MODULE.....	91	DEMONSTRATION SONGS.....	119
ZONES.....	92	SPECIFICATIONS.....	120
◆ INTERNAL ZONES.....	92	SERVICE.....	121
◆ EXTERNAL ZONES.....	92		
◆ PANIC FUNCTION and PARAMETER RELOAD.....	93		
MIDI.....	94		
◆ MIDI TEMPLATE.....	94		
◆ MASTER.....	94		
◆ CHANNELS.....	95		
SAVE THE SETUP.....97			
SAVE THE SETUP.....	98		
About CF Card.....	98		
◆ RECOMMENDED CF CARDS.....	98		
◆ CF CARD SLOT.....	98		
◆ THE CONTENT AND CAPACITY TO BE SAVED.....	98		
INITIALIZE THE CF CARD.....	99		
SETUP MODE.....	100		
How to read the display.....	100		
Save the Setup.....	100		
Change the SETUP Name.....	101		
Load the Setup.....	102		
How To Delete the Setup.....	102		
FREQUENTLY ASKED QUESTIONS.....103			
TROUBLESHOOTING.....	104		
INSTRUMENT CARE.....	105		
APPENDIX.....107			
CUSTOM TONE WHEEL PRESETS.....	108		
MIDI TEMPLATES.....	109		
CHANNELS AND MIDI MESSAGES.....	109		
MIDI INFORMATION.....	110		

Index

B

Back-Up 22
Bank 24

C

Cabinet Number 74
CF Card 98
Click 62
Control 66
Control Panel 52
Coupler 68
Custom Tone Wheels 70
Cut Off Frequency 71

D

Damper 67
Decay Rate 63
Default 82
Display 67
Display Lock 60
Drawbar 62
Drawbars 34

E

Equalizer 80
Expression 67, 93
Expression Pedal 25
External Leslie Speaker 76
External Zone 88, 92

F

Fold-Back 62
Foot Switch 25, 66
Function Mode 56

G

Great To Pedal 28

I

Instrument Care 105

K

Keyboard Channels 88
Key Track 73

L

Leakage Noise 71
Leslie 27, 42, 74
Leslie Parameter 74

M

Menu Mode 54
MIDI 86

N

Name 47
Number 24

O

Octave 92
Overdrive 78

P

Pan 92
Pedal Sustain 28, 45
Pedal To Great 28
Pedal To Swell 68
Percussion 26, 40, 73
Play Mode 53
Preset 64
Preset Load 64
Preset Name 64

R

Rebound 83
Record 48
Registration 36
Reset 22
Resonance 71
Reverb 27, 81

S

Sequencer 89
Short Cut 57
Sounding Point 68
Storing 29
Sustain Length 63
System 83

T

Tone wheels 62
Transpose 49
Troubleshooting 104

Tune 69

V

Velocity 63, 73, 92
Vibrato & Chorus 27, 41, 78
Volume 92

Z

Zones 92

◆ ACCURATELY REPRODUCES THE TONE WHEEL SOUND

Your new A-162 contains 96 independent oscillating digital tone wheels that accurately reproduce the sound of the Vintage B-3/C-3/A-100.

In addition, this organ has full polyphony as on the B-3/C-3/A-100.

◆ ADVANCED DIGITAL LESLIE / VIBRATO EFFECTS

The A-162 is equipped with a proprietary effect generator to reproduce the Scanner-Vibrato and Leslie Speaker. The range of sound you can create is expanded by the use of Vibrato and Chorus effects, and by the real sounding Leslie effects which effectively replicate the effect of the two Rotors which are present in traditional Leslie Speakers.

◆ EQUALIZER AND TONE CONTROL

A 3-band equalizer and tone-control are now built in. The equalizer can make fine or course tonal adjustments to the bass, treble, and mid frequency ranges. The tone control simulates the circuit built in on the vintage B-3/C-3/A-100 pre-amp to obtain a gently-cut treble.

◆ CompactFlash™ CARD SLOT

A Compact Flash card is utilized to record the setup data.

◆ MIDI MASTER KEYBOARD

An external zone is available on each manual and pedalboard to enable this organ to be used as a master keyboard.

◆ 50W 3CH AUDIO AMPLIFIER

The A-162 has a built-in 50 watt 3-channel (Left, Right and Center/Bass) amplifier, enabling you to get a full range of sound from the self-contained speaker system.

Components

Organ

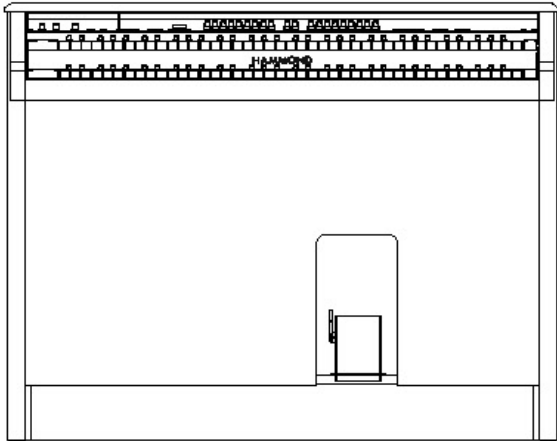

Music Rack

(Attached under the lid of the bench)



A. C. Power Cable



Pedalboard

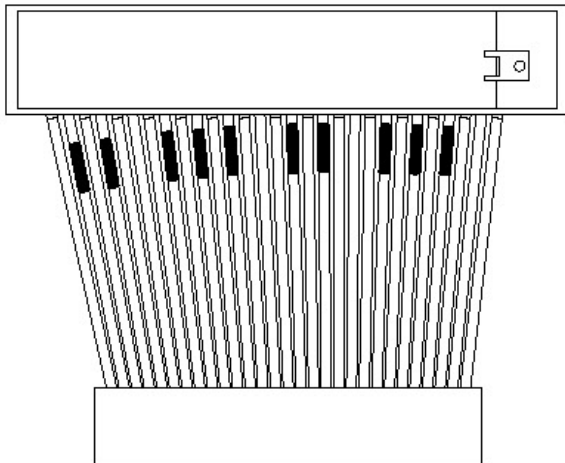

Bench



Connect the Pedalboard

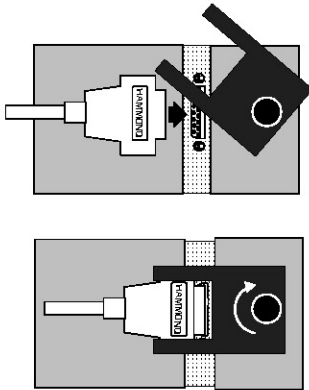

1. Place the Pedalboard on the floor in front of the organ.
2. Take the Pedal Cable out of the organ and insert the plug into the connector on the Pedalboard.
3. Hold the plug with the “Retention Hook” and lock it on by turning the screw knob.
4. Slide and push in the Pedalboard beneath the organ until it stops.

Bench

The space underneath the top board of the bench is provided for storing scores, music rack, etc.

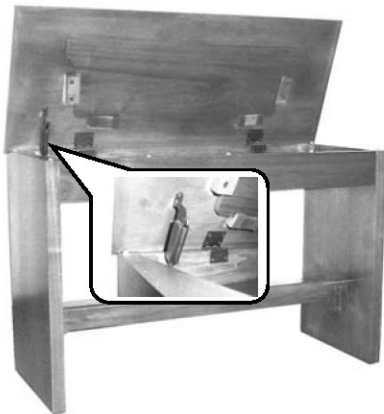

⚠CAUTION

Be careful not to pinch your fingers in the folding metal arms when you close the lid.

Do not adjust the position of the bench while sitting. Avoid the risk of pinching your fingers between the lid and the box.

⚠ATTENTION

Don't tilt the bench when moving it to avoid books etc. dropping out of the box.

Do not put anything taller than 5cm (2") into the bench. The lid will not close and the contents may be damaged.

Put on the Music Rack

Insert the Music Rack into the rail whenever necessary.

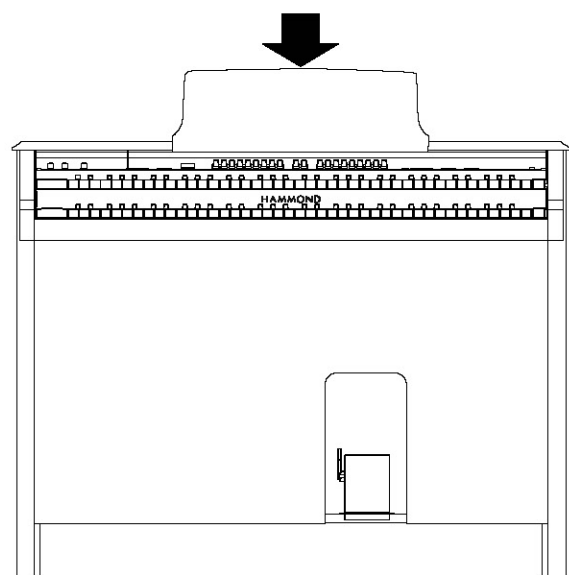

⚠ATTENTION

Do not place heavy volumes or folios on the music rack.

Top Panel

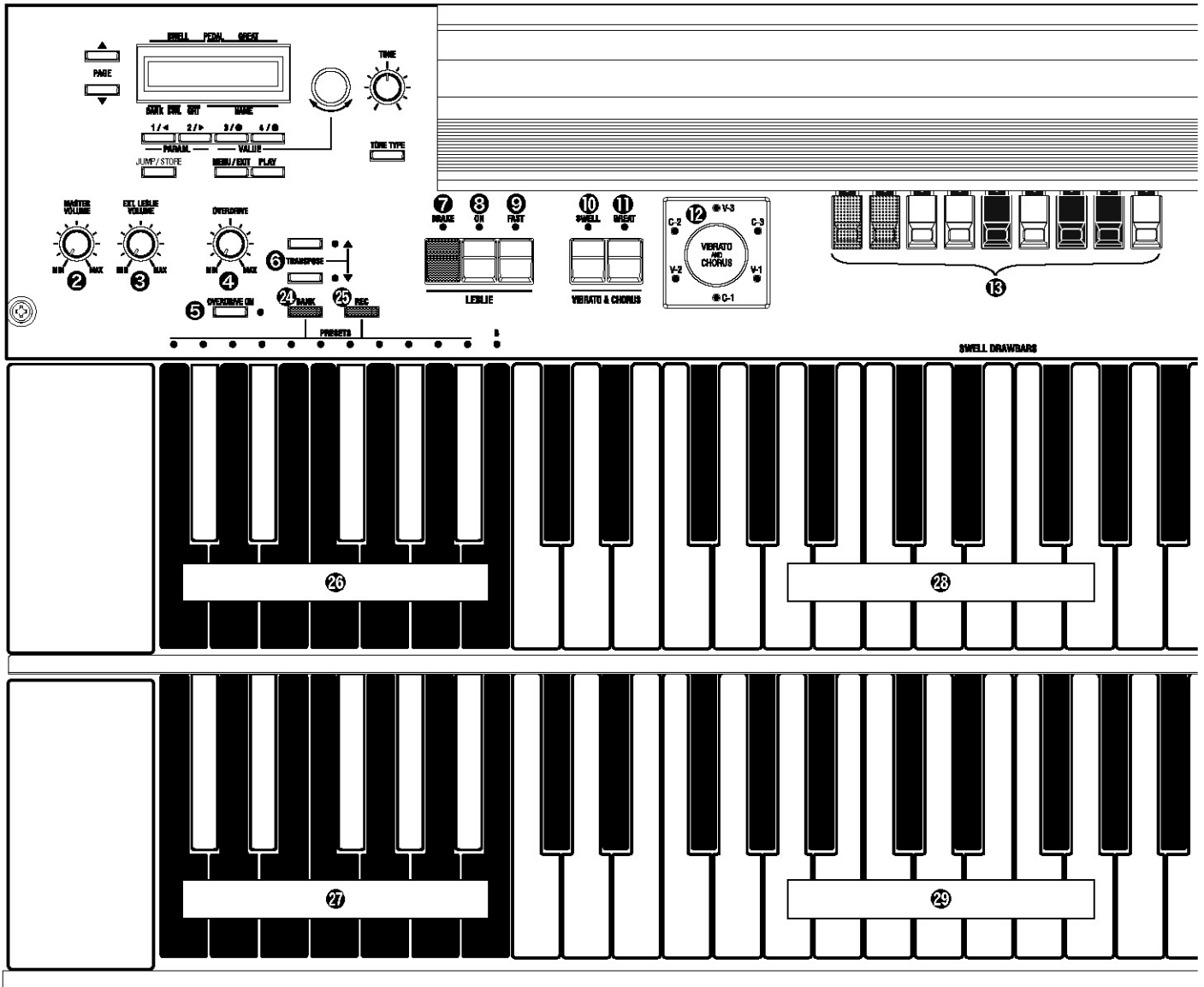

◆ UPPER RIGHT

❶ POWER Switch

This switch turns the power “ON” and “OFF.” (P. 22)

⚠ CAUTION

Even when the POWER is turned “OFF,” electricity is still flowing to the instrument at the minimum level. When you are not using the instrument for a long time, make sure you unplug the power cord from the wall AC outlet.

◆ UPPER LEFT

❷ MASTER VOLUME Knob

Controls the total volume of internal speakers, headphones and line out jack. (P. 22)

❸ EXT. LESLIE VOLUME Knob

Controls the total volume of an external Leslie Speaker.

❹ OVERDRIVE Knob

Controls the amount of the overdrive effect. (P. 43)

HAMMOND A-162 Owner's Manual

❺ OVERDRIVE ON Button

Switches the Overdrive effect “ON” and “OFF.” (P. 43)

❻ TRANSPOSE Buttons

Transposes the entire organ up or down by semitones. (P. 49)

◆ LESLIE

❼ LESLIE BRAKE Button

Switches the Through or Brake mode if the LESLIE ON button is “OFF.” (P. 42)

❽ LESLIE ON Button

When “ON,” (LED lit), the rotor turns and the sound comes through the Rotary channel.

When “OFF,” (LED not lit), the sound is heard through the Stationary channel. (P. 42)

❾ LESLIE FAST Button

When “ON,” (LED lit), the rotors turn at Fast or Tremolo speed.

When “OFF,” (LED not lit), the rotors turn at Slow or Chorale speed. (P. 42)

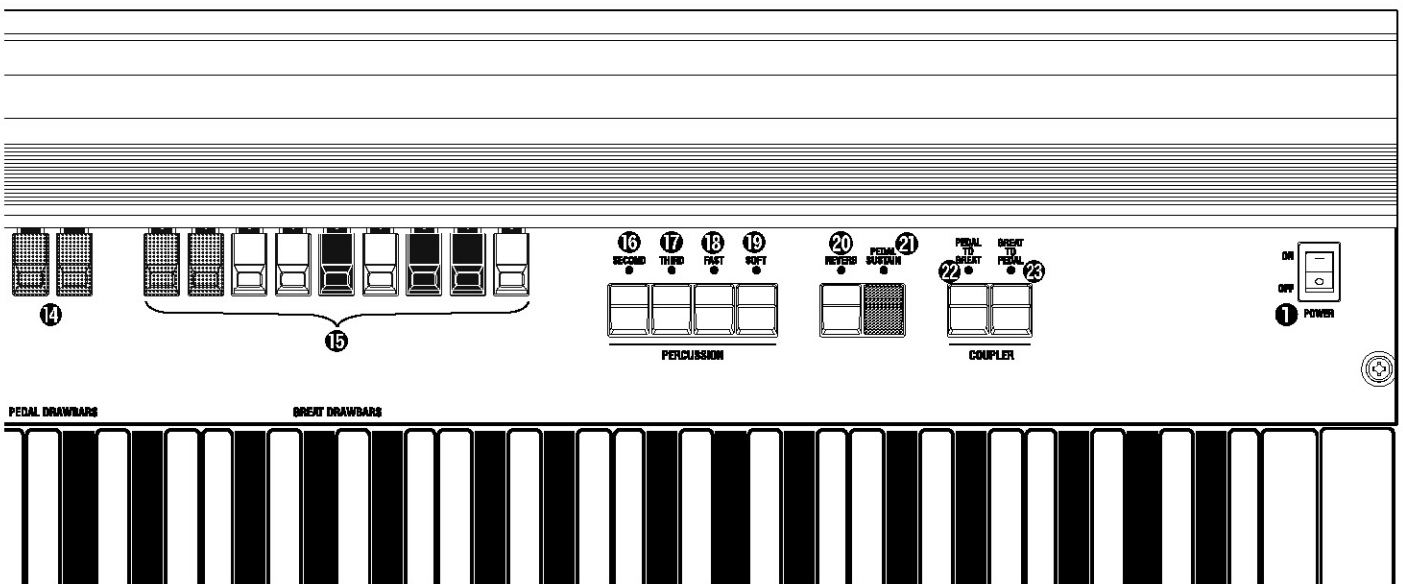

◆ VIBRATO AND CHORUS

10 SWELL ON Button

Switches the Vibrato and Chorus effects “ON” and “OFF” on the SWELL Drawbar part. (P. 41)

11 GREAT ON Button

Switches the Vibrato and Chorus effects “ON” and “OFF” on the GREAT Drawbar part. (P. 41)

12 VIBRATO AND CHORUS MODE Knob

Changes the depth of Vibrato and Chorus Effects. (P. 41)

◆ DRAWBARS

13 SWELL DRAWBARS

Control SWELL manual harmonics. (P. 34)

14 PEDAL DRAWBARS

Control Pedalboard harmonics. (P. 34)

15 GREAT DRAWBARS

Control GREAT manual harmonics. (P. 34)

◆ PERCUSSION

16 SECOND ON Button

Adds 4' Percussion (decay sound) to SWELL manual. (P. 40)

17 THIRD ON Button

Adds 2 $\frac{2}{3}$ ' Percussion (decay sound) to SWELL manual. (P. 40)

18 DECAY FAST Button

Changes decay time of Percussion. (P. 40)

19 VOLUME SOFT Button

Changes Percussion volume. (P. 40)

◆ REVERB

20 REVERB Button

Switches the Reverb effect “ON” and “OFF” (P. 45)

◆ SUSTAIN

21 PEDAL SUSTAIN Button

Switches the Pedal Sustain effect “ON” and “OFF” (P. 45)

◆ COUPLER

22 PEDAL TO GREAT Button

This is for playing the PEDAL part using the GREAT manual. (P. 45)

23 GREAT TO PEDAL Button

This is for playing the GREAT part using the Pedals. (P. 45)

◆ PRESETS

24 BANK Button

Switches Banks by pressing this button together with the SWELL Preset Keys. (P. 24)

25 RECORD Button

Records Presets by pressing this button together with each Preset Key. (P. 29)

26 SWELL Preset Keys

Selects a Preset for the SWELL part.

The “B” Preset Key is called the “ADJUST” preset. Use this key when you want to use the SWELL Drawbars. The position of the Drawbars will correspond to the setting shown in the display. (P. 26)

27 GREAT Preset Keys

Selects a Preset for the GREAT and PEDAL part.

The “B” Preset Key is called the “ADJUST” preset. Use this key when you want to use the GREAT Drawbars. The position of the Drawbars will correspond to the setting shown in the display. (P. 26)

◆ MANUALS

28 SWELL Manual

61 notes, velocity-sensitive.

29 GREAT Manual

61 notes, velocity-sensitive.

Upper Left

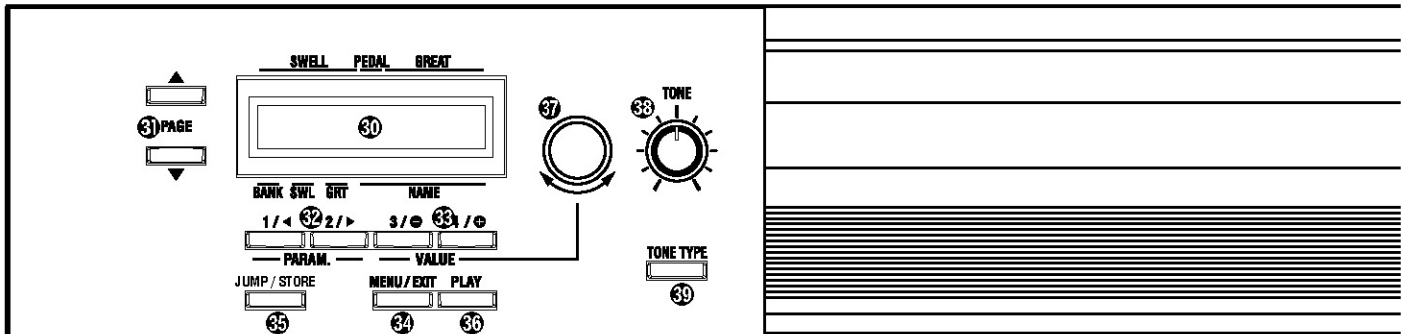

◆ CONTROL PANEL

30 Display

Various information is displayed here. (P. 52)

31 PAGE Buttons

This is used to scroll through the various pages of controls and parameters. (P. 52)

32 PARAM Buttons

This is used for selecting the parameter item to edit, also to select items #1 and #2 on the basic edit pages. (P. 52)

33 VALUE Buttons

This is used to increase or decrease values, also to select items #3 and #4 on the basic edit pages. (P. 52)

34 MENU Button

This is for calling the MENU mode, also for exiting from various function modes, and jump to function modes. (P. 52)

35 JUMP/STORE Button

This allows you to quickly call a pre-selected menu item directly. (P. 52)

36 PLAY Button

This selects the basic Play mode. (P. 52)

37 VALUE Knob

This adjusts the value of the selected parameter.

38 TONE Knob

This adjusts the gain of a band of the equalizer.

39 TONE TYPE Button

This selects the frequency band to control by the TONE knob.

Underside Of Manual

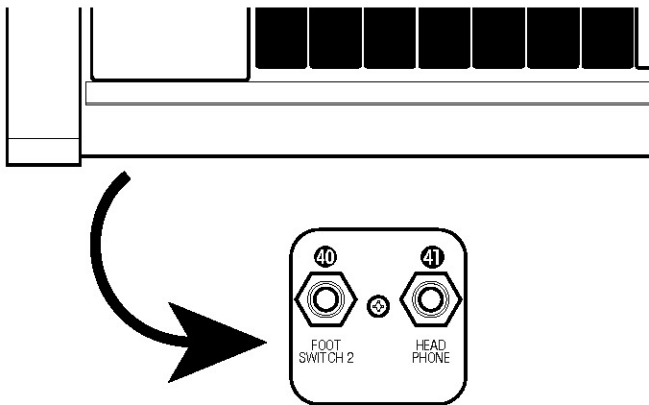

40 FOOT SWITCH 2 Jack

This jack is for a Foot Switch (= FS-9H - optional) and the Leslie Switch (= CU-1 - optional).

You can switch the speed of the Leslie effect, change Presets, etc. while playing. (P. 20)

41 HEADPHONES Jack

This is for connecting the stereo headphones. The speakers are silenced when a plug is inserted into this jack. (P. 19)

Rear Panel

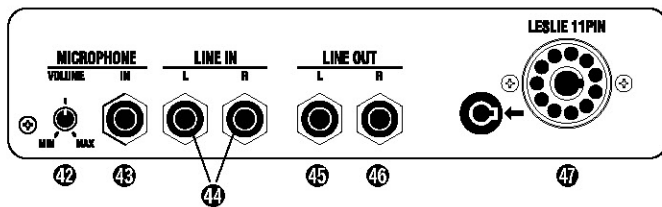

42 MICROPHONE VOLUME Knob

This adjusts the volume of the microphone (#43).

NOTE: The microphone volume can be adjusted with the **MASTER VOLUME (#2)** and **EXT. LESLIE VOLUME (#3)** knob.

43 MICROPHONE Jack

If you plug a microphone into this jack, you can use the organ as a public-address system.

NOTE: Feedback could be produced depending on the location of microphone relative to speakers. This can be prevented by:

- Changing the position of the microphone.
- Relocating microphone at a greater distance from speakers.
- Lowering volume levels.

44 LINE IN L, R Jack

This is the input for an external sound module or a CD player. The incoming audio signals to this jack are routed to the built-in speakers, LINE OUT jack, HEADPHONE jack, and the stationary channel of Leslie Speaker.

NOTE: The line in volume can be adjusted with the **MASTER VOLUME (#2)** and **EXT. LESLIE VOLUME (#3)** knob.

45 LINE OUT L Jack

This is the Left channel output of this organ.

46 LINE OUT R Jack

This is the Right channel output of this organ.

Use the Left and Right output jacks if your mixer or amplifier has more than one input.

47 LESLIE 11 PIN Socket

Connect the Leslie speaker here. (P. 18)

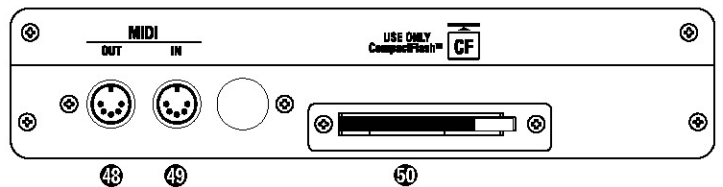

48 MIDI OUT Jack

Sends out the performance information of this organ. (P. 86)

49 MIDI IN Jack

This jack is for playing the keyboard channels (SWELL, GREAT, PEDAL) from external MIDI equipment. (P. 86)

50 CF Card Slot

Insert the CompactFlash Card here.

51 AC Inlet

Connects the A.C. Power Cable

⚠ CAUTION

This Organ should be connected to a MAINS socket outlet with a protective earth connection.

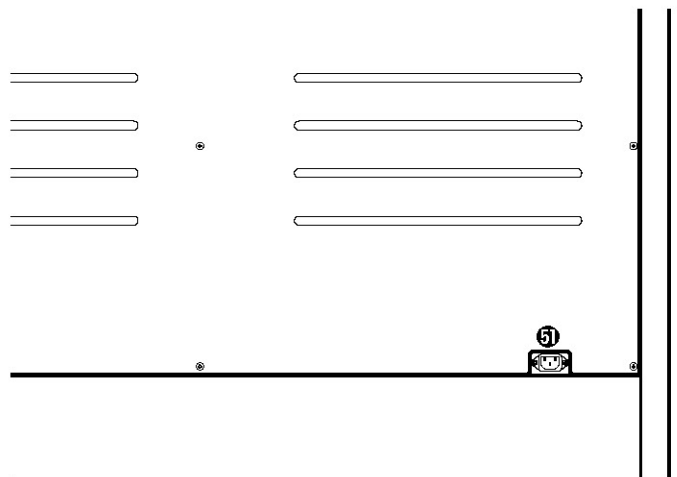

Pedals

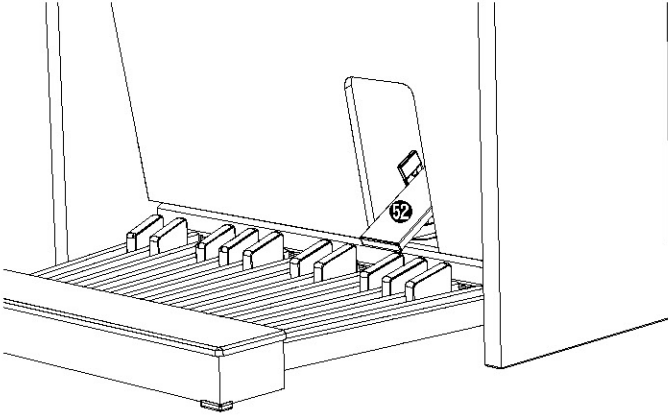

52 **EXPRESSION Pedal**

This is for changing the total dynamics of the organ.
The Foot Switch is attached on the top left. (P. 25)

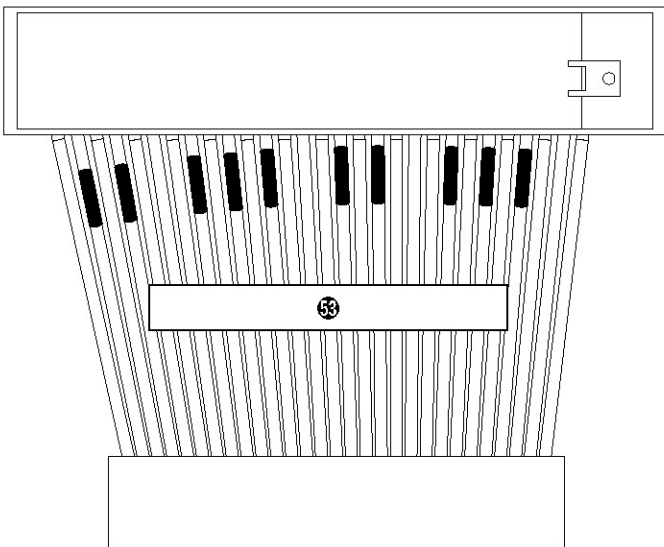

53 **Pedalboard**

25 notes. Radial flat type, non-velocity.

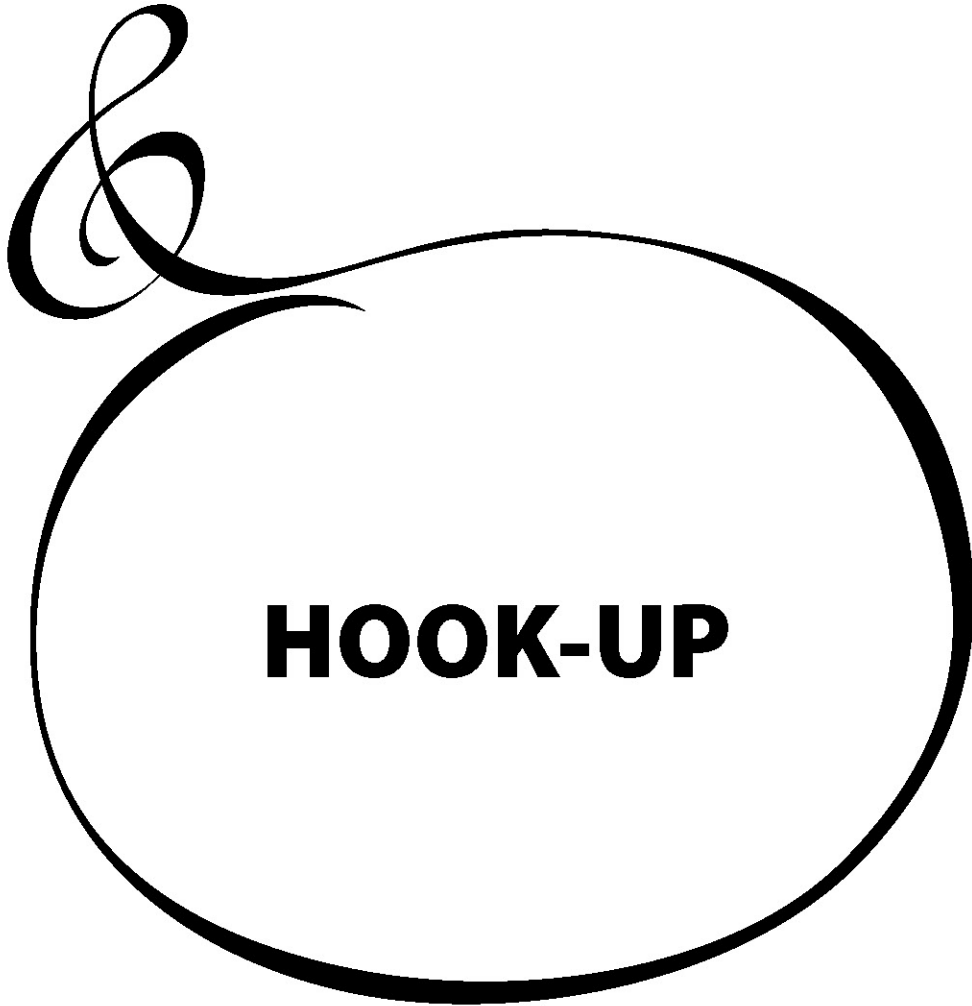

BASIC HOOK-UP

This organ has a built-in speaker system, so you can start playing immediately after connecting to the power source by inserting the AC plug to the AC outlet.

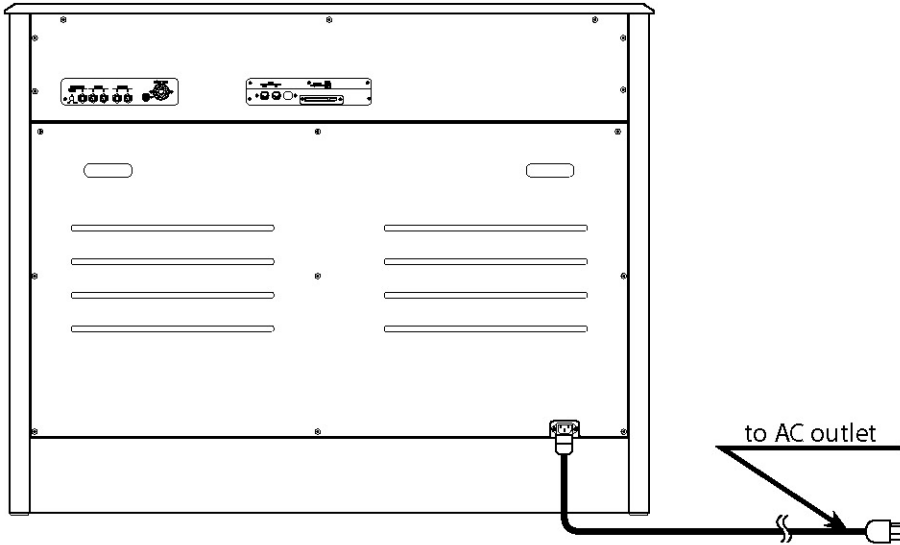

⚠ CAUTION

Do not expose this organ to any excessive heat sources such as direct sunlight or flames.

CONNECTING THE LESLIE SPEAKER

This organ is equipped with an 11-pin Leslie connector, so you can directly connect a Leslie Speaker.

❖ *Make this connection with the Organ power OFF.*

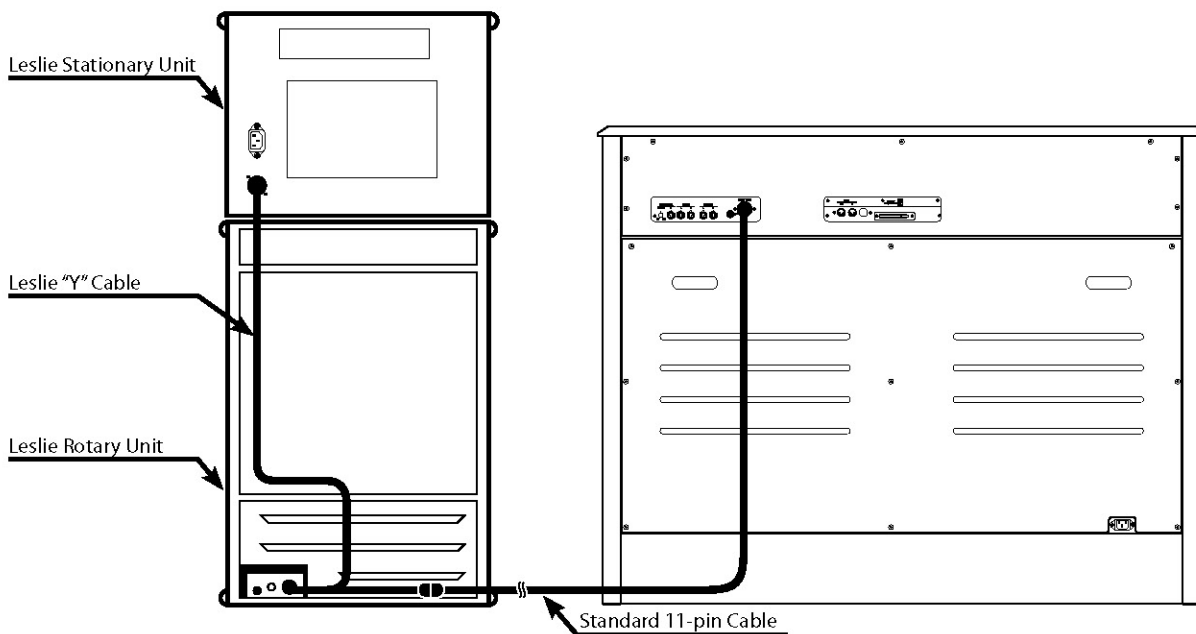

Connect the Leslie Speaker to the 11-pin terminal on the organ, with the exclusive 11-pin Leslie Cable (to be separately purchased along with other Leslie Speaker accessories).

Adjust the setting of the "EXT. LESLIE CH", in accordance with the Leslie Speaker connected. (P. 76)

eg. Typical Leslie Speaker Connections

122XB, 3300, 771, 971, 981 -- 1CH

2101, 3300 / 971 with Stationary Unit -- 3CH

3301 / 525 with exclusive Y cable -- 3CH

Please consult the User's Guide of the Leslie Speaker you are using.

Each Manual and the Pedalboard on this organ has an External Zone for controlling external MIDI sound modules. When Connected to the LINE IN jacks, the external MIDI sound module output is sent to the built-in speakers, stationary channel of the Leslie terminal (on a multi-channel Leslie), the LINE OUT jack and the headphone jack.

NOTE: Adjust the volume of the equipment connected to the LINE IN jack on the external equipment itself.

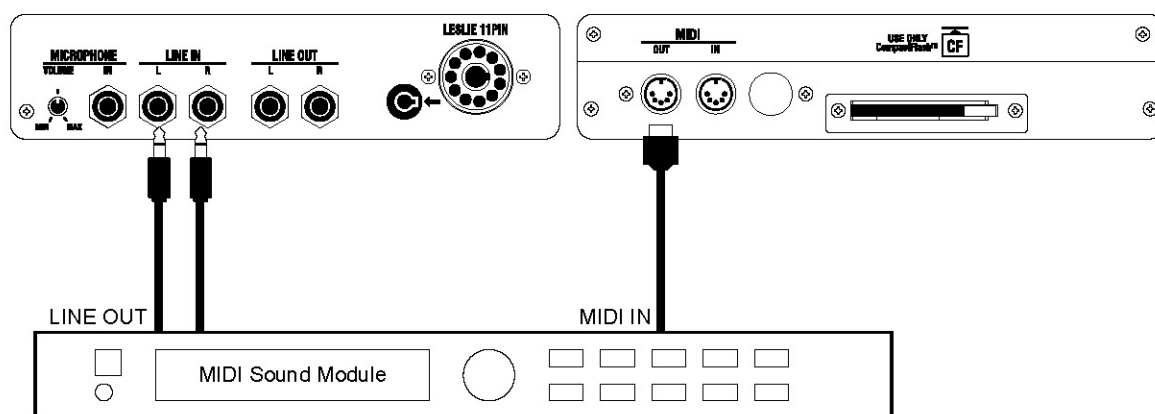

USING HEADPHONES

You can practice silently by connecting a set of stereo headphones to the HEADPHONE jack of this organ.

When the plug is inserted into the HEADPHONE jack, the built-in / external Leslie speakers are silenced.

⚠ ATTENTION

Hold the molded part of the plug of the cord when you connect or disconnect it to avoid the risk of breaking the cable.

Do not use excessive volume with headphones, so as not to risk hearing damage.

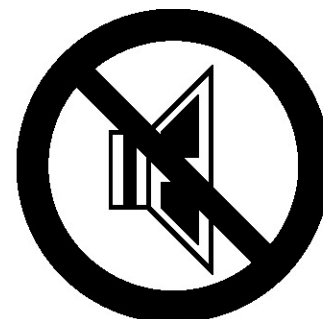
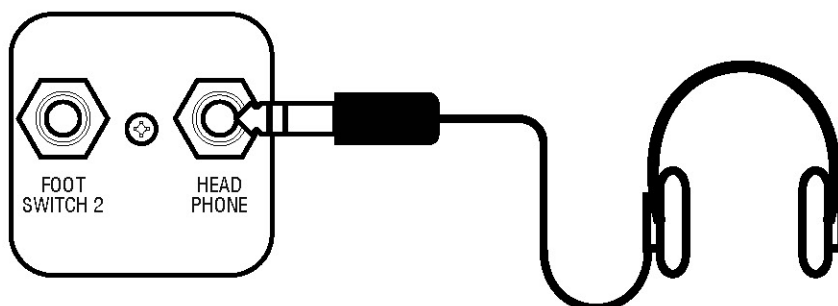

USING AN EXTERNAL FOOT SWITCH

This organ has a foot switch attached to the Expression Pedal. If necessary, you may also add an external foot switch. In that case, connect an unlatch-type foot switch to the "FOOT SWITCH" jack on the underside of the key bed. The Hammond FS-9H (optional) is recommended.

The "FOOT SWITCH" jack is tip-ring-sleeve. So you may connect a twin-pedal-type foot switch with a stereo plug to this jack.

After this connection, set the FOOT 2 DEVICE at "PEDAL" in the "CONTROL - FOOT SW" mode. (P. 67)

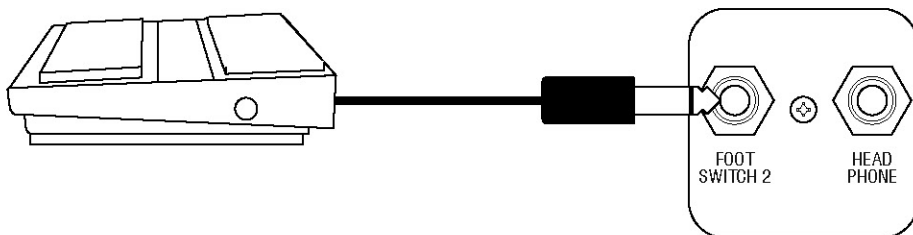

USING A LESLIE CONTROL SWITCH

You may connect a model CU-1 (traditional "half-moon" Leslie speed switch).

To connect a CU-1 to the organ, do the following:

1. Remove the wooden spacer included with the CU-1 kit.
2. Mount the CU-1 on the front rail to the left of the GREAT Manual. You will see pre-drilled holes for the two screws holding the CU-1 on the underside of the front rail (see diagram below).
3. Connect the plug to the "FOOT SWITCH 2" jack located underneath the front rail.

After this connection, set the FOOT 2 DEVICE to "CU-1" in the CONTROL - FOOT SW" mode. (P. 67)

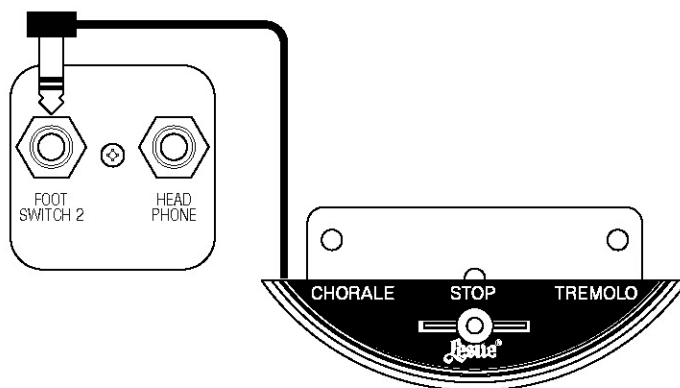
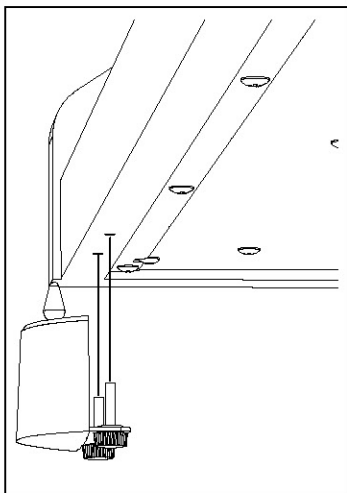

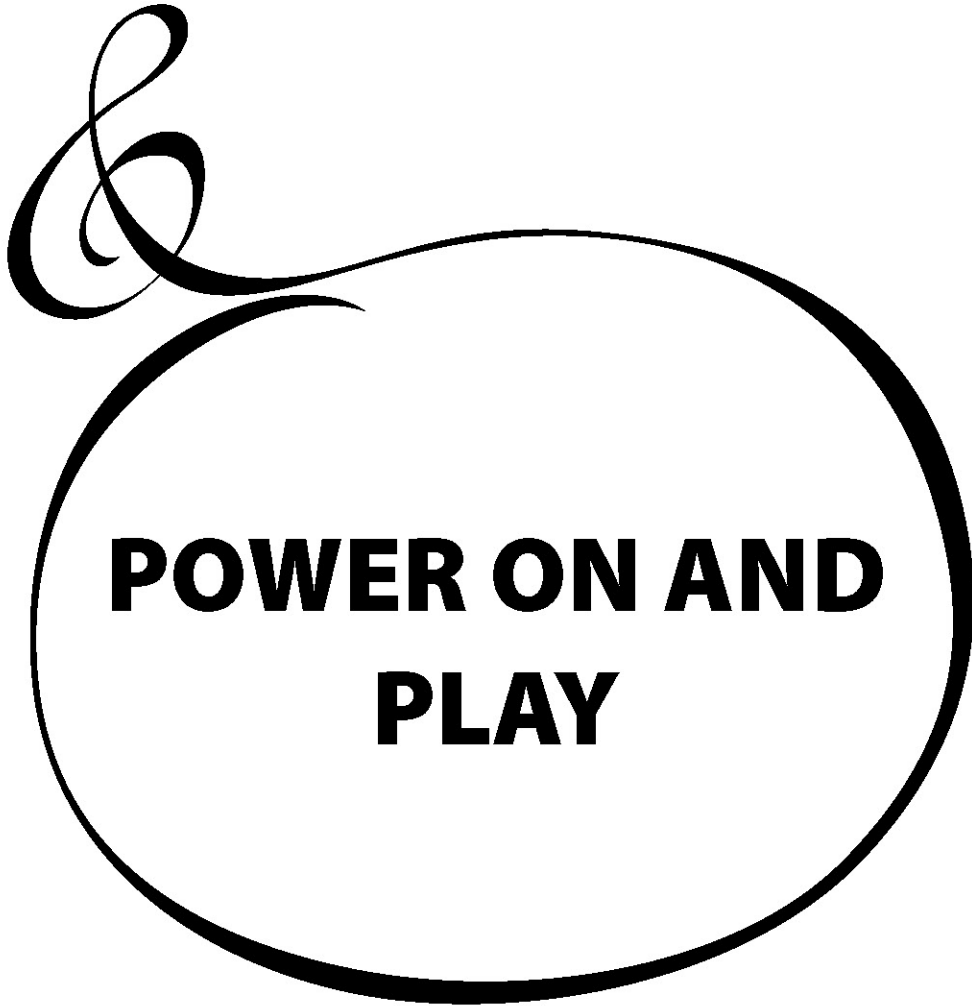

**POWER ON AND
PLAY**

How to power on

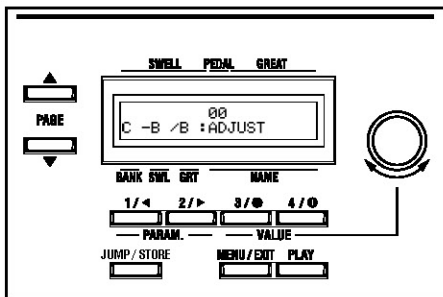
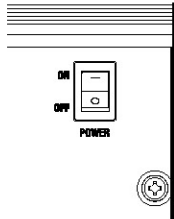
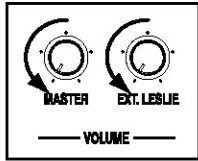

After connecting your A-162 to the power outlet, please perform the following procedure before switching on the power. To avoid possible damage to speakers, please do not vary the procedure.

◆ STEPS TO TAKE

1. Set the [MASTER VOLUME] knob at 0 (minimum), before switching the power on.
2. Turn the power to the organ "ON" with the Power Switch on the right side. After approximately 2 seconds, several LEDs on the buttons will turn "ON." This indicates that the organ is ready to play.

NOTE: If you raise the lid on the left side just above the 3 Rotary Knobs, you will see the LCD display. When you first turn the organ "ON," this display will scroll an introductory message, after which the PLAY Mode will display. More information about the display is contained in later sections of this Guide.

Also, if an external Leslie Speaker is connected to the organ, it will automatically switch "ON" when the organ is turned "ON."

- ❖ *The circuit protection device creates a delay of a few seconds before the A-162 is ready to play.*
3. If an external amplifier is connected to the organ via the LINE OUT jacks, switch it "ON."
 4. Touch [a Preset Key] - use any Preset Key from "C#" through "A#."
 5. Holding down a key, adjust the [MASTER VOLUME] (and [EXT. LESLIE VOLUME]) by turning each knob.
 - ❖ *The "C" and "B" Preset Keys normally do not produce sound when the organ is first turned "ON" and no Drawbars are out. Pull out the Drawbars, or press either of the "C#" - "A#" Preset Keys to start.*
 6. Adjust the volume of the amplifiers etc.
 - ❖ *Reverse the above steps when you switch the power "OFF." Also, be sure to switch the power to a connected amplifier "OFF" before switching the organ "OFF."*

Switch-off memory

Your A-162 memorizes the setting of the organ immediately before it is switched "OFF." Therefore, the organ will start with these settings when the organ is next switched "ON." The A-162 is initially shipped from the factory with the "B" Preset Key selected "ON." (LED lit)

Reset to the factory settings

Please perform the following steps to reset the A-162 to the initial default setting.

◆ STEPS TO TAKE

1. Switch the power to the organ "OFF"
2. Holding the [RECORD] button, switch the power "ON."
3. Continue to hold the [RECORD] button until "Loading Default..." appears on the Display.
4. After doing the above steps, the "PLAY mode should appear in the display. The organ is now restored to factory-default settings.

LISTEN TO THE DEMONSTRATION PERFORMANCE 23

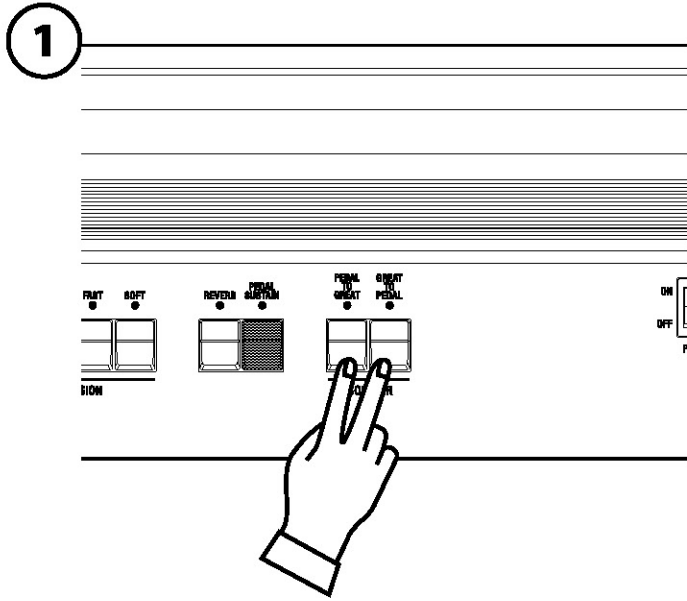

Touch and hold the [PEDAL TO GREAT] and [GREAT TO PEDAL] buttons for 2 seconds.

The Display will be as shown in step 2.

NOTE: You can locate this mode another way. From either of the PLAY screens, touch the [MENU] button to display the MENU, touch the [PAGE ▲] button five times to select Menu F, then touch [1] DEMO.

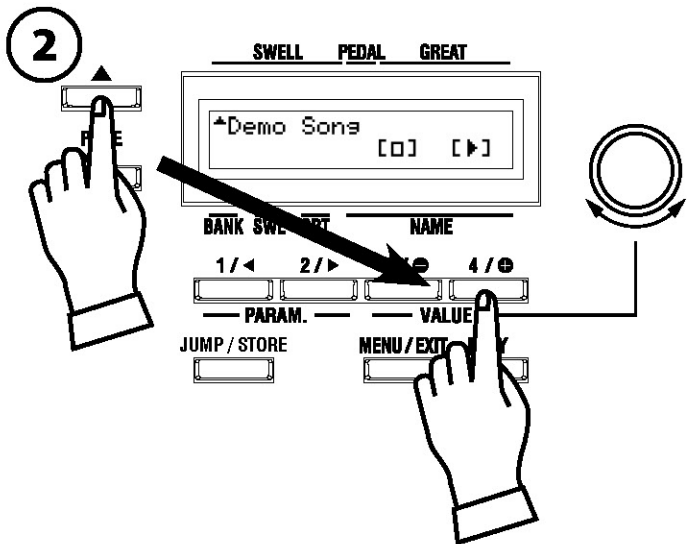

Touch the [PAGE] button and select a desired song.

The performance starts when the [4] “▶” button is touched.

NOTE: After the song is over, the next one starts automatically.

To select a new song while you are playing, touch the [3] “□” button. The performance that is playing will stop.

NOTE: While the demonstration songs are playing, only the MASTER VOLUME and EXT. LESLIE VOLUME Rotary Controls and the LESLIE ON, LESLIE FAST, VIBRATO/CHORUS and TRANSPOSE controls will function.

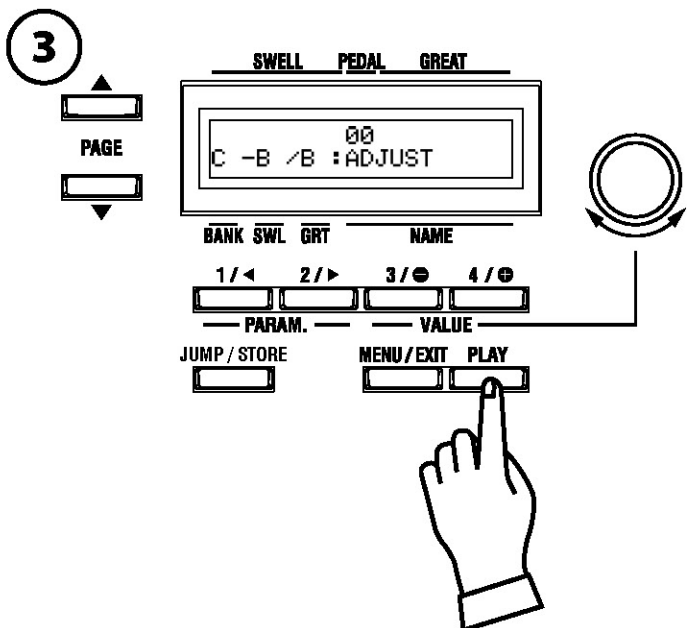

To stop the performance, touch either the [MENU] or [PLAY] button.

USING THE COMBINATION PRESETS

The registrations (settings) of the Drawbars and other parameters may be recorded to the Preset Keys on the left-hand side of each manual.

The 11 Banks are loaded with a default library of Presets allowing you to play your organ immediately.

There are 12 Banks with 10 Presets in each.

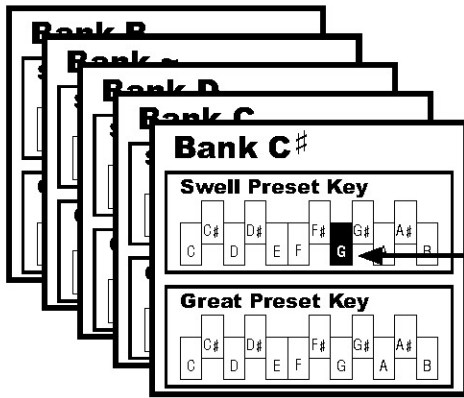

The chart on the left outlines the Bank/Preset structure.

The "Bank" is common for the entire organ, but the Preset Keys for the SWELL and GREAT are independent of each other and are selected separately.

The example shown below illustrates this in greater detail.

How to recall the Preset

◆ Ex. Select C#-G

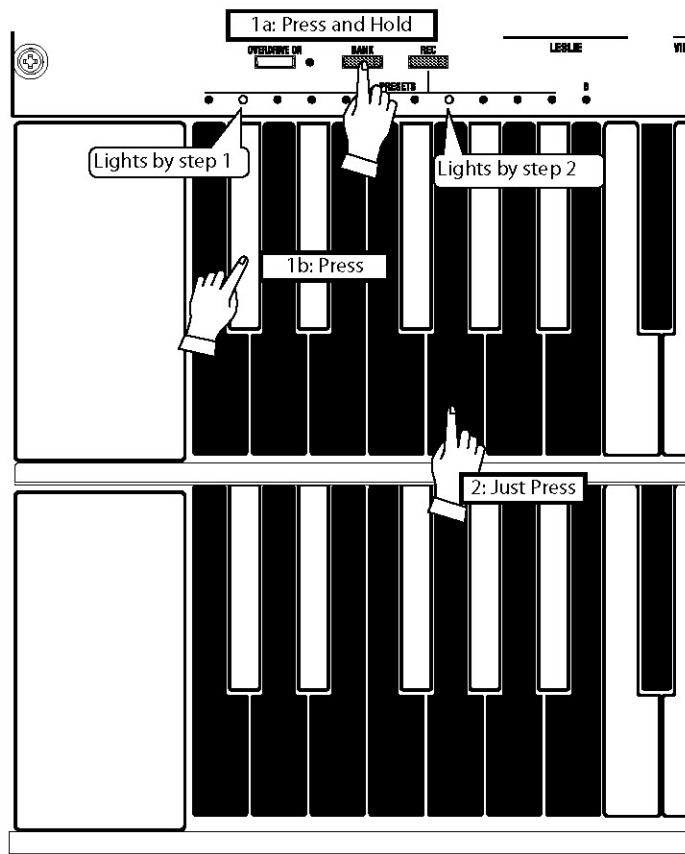

1. Select the BANK

While holding down the [BANK] button (1a of the left figure), press the "C#" Preset Key (1b).

NOTE: The LED for the Preset Key indicates the "BANK", while the [BANK] button is touched.

2. Select the KEY

Press the "G" Preset Key (2 of the left figure).

At this time the Preset is selected and the setting changes.

NOTE: While the [BANK] button is released, the red LED indicates the "KEY" for SWELL, green LED indicates "KEY" for GREAT.

Try calling various Presets. See the Appendix "Factory Presets" (P. 118) for details of the contents of each Preset.

NOTE: On the B-3/C-3/A-100, only Drawbar settings could be changed with the Preset Keys, which also is the default setting for this organ. However, the A-162 can memorize other parameters in addition to the Drawbar settings. See the "PRESET" section for details. (P. 64)

Using the performance controllers will add expression to your playing. On this page you will learn how to use these controllers. The controllers exclusive to the Hammond are covered on the next page.

Expression Pedal

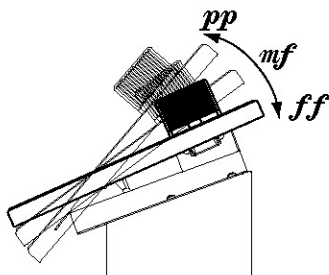

The overall volume is controlled by using the Expression Pedal. As you depress the pedal forward, the volume rises, and lowers when you return it.

NOTE: You can adjust the range of the expression pedal. (P. 66)

Power On And Play

Foot Switch

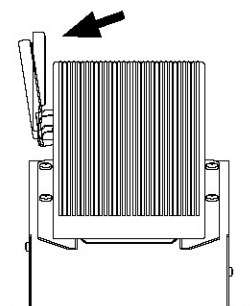

The Foot Switch on the left side of the Expression Pedal can be programmed for various functions. "Leslie Slow / Fast - Alternate" is the factory default. Each time the Foot Switch is engaged, the Leslie changes mode.

NOTE: You can change the Foot Switch assignment. (P. 66)

NOTE: You can add an external Foot Switch or Leslie Control switch. (P. 20)

TRY MAKING YOUR OWN SOUND

You will be able to produce your own sound by using the exclusive features of your Hammond Organ, such as Drawbars, Percussion, Vibrato & Chorus, Leslie effects, and Reverb. Let's go through the first steps:

Select the SWELL "B" Preset Key

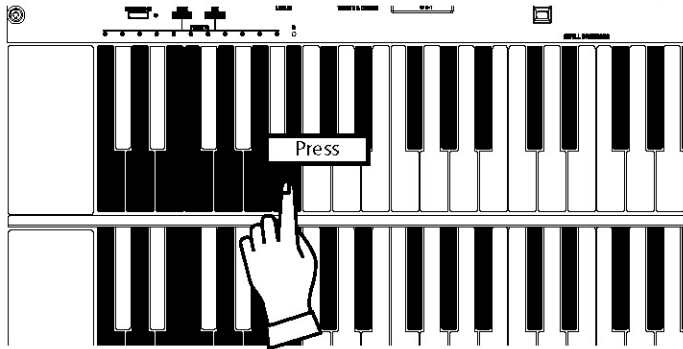

Select the SWELL "B" Preset Key first.

The "B" Preset Key is called the "Adjust Preset". This means the Drawbar registrations on the panel and each position of buttons or knobs and internal values correspond with each other.

Selecting these keys is helpful when you create a new registration or when you want to manually operate the Drawbars while playing.

NOTE: You can initialize the contents to the default setting. (P. 82)

Pull out the SWELL Drawbars

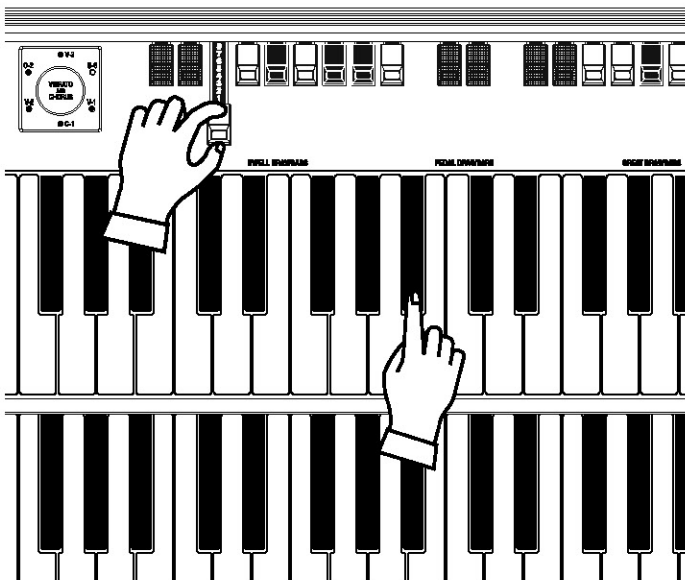

Pull out the SWELL Drawbars on the left-hand side to your desired length, while holding a key on the SWELL manual.

The tone varies according to the extent or the length of the Drawbar. It is the Drawbars that create the fundamental tones of this organ.

The volume gets louder as each Drawbar is pulled out to the full length. The sound gets silent when it is totally pushed back. The tones of the Drawbars gradually get higher in frequency from left to right.

NOTE: You can change the characteristics of the Drawbars (P. 62).

NOTE: The current registration is shown on the "Play" mode display (P. 53).

Add Percussion

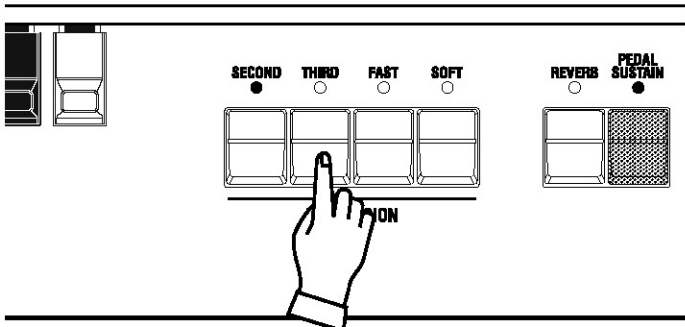

The "Percussion" referred to here is not a percussion instrument itself, but a "decay" to add a clear-cut "attack" to the organ sound. You can add this "attack" to mix with the Drawbar sound when you want.

If you switch the [SECOND] and [THIRD] buttons "ON," Percussion tones (= one octave higher "C" and "G") are added.

If you switch the [FAST] button "ON," the Percussion sounds fades quickly. Switching the [SOFT] button "ON" reduces the volume of the Percussion sound.

NOTE: You can fine-adjust the volume, etc. of the Percussion (P. 73).

Add effects

◆ Vibrato and Chorus

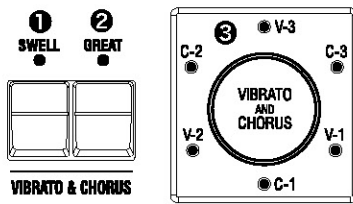

“Vibrato and Chorus” slightly changes the Drawbar pitch at a certain ratio and adds warmth to the sound.

1 [SWELL] Button

2 [GREAT] Button

Switches the Vibrato effect “ON” and “OFF.” When the button is “ON”, the LED will light.

3 [VIBRATO and CHORUS MODE] Knob

Selects Chorus or Vibrato and the depth of each.

The degree of depth corresponds with the number.

NOTE: You can fine-adjust the speed etc. of the Vibrato and Chorus. (P. 78)

◆ Leslie

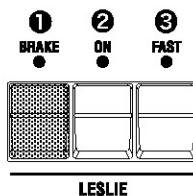

The organ has a digital LESLIE™ Effect with virtual “horn” and “rotor”, duplicating the effect of the classic electro-mechanical Leslie™ speaker system.

2 [ON] Button

Switches the Leslie effect “ON.” When the button is “ON”, the LED will light.

3 [FAST] Button

This button controls the rotor at two different speeds. When the LED is “ON,” it is FAST. When the LED is “OFF,” it is SLOW.

1 [BRAKE] Button

This is to set the Leslie action when the [ON] button is “OFF.”

When the LED is “ON,” the BRAKE mode is active. The rotation gradually slows down and stops. When the LED is “OFF,” the THROUGH mode is active. The Leslie effect is by-passed.

NOTE: These switches will also control a connected Leslie Speaker.

NOTE: The speed, tonal characteristics and other parameters of the Digital LESLIE™ are easily adjustable. (P. 74)

◆ Reverb

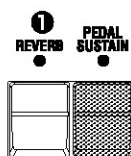

The reverb effect simulates performing in a concert hall or other acoustic space.

1 [REVERB] Button

Switches the effect “ON” and “OFF.” When the Reverb effect is “ON”, the LED will light.

NOTE: You can fine-control the depth, time, etc. of the Reverb. (P. 81)

This organ has also built-in effects such as Overdrive(P. 78)and Equalizer(P. 80). See the details on these pages.

Pedal Sustain

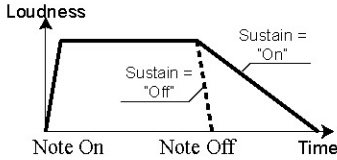
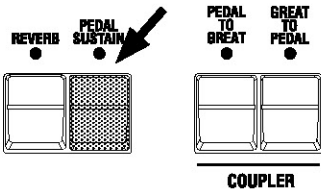

The PEDAL Drawbar sound can be set to smoothly decay after the pedal is released. This is called “PEDAL SUSTAIN”.

To use this “Pedal Sustain” function, switch the [PEDAL SUSTAIN] button “ON.” The LED will light.

If you release your foot off the Pedal (or your finger from the GREAT manual, if you are using the Pedal to Great, as explained later in this manual), the PEDAL Drawbar sound smoothly decays.

NOTE: You can change the decay time of the Pedal Sustain. (P. 63 #10)

Pedal To Great

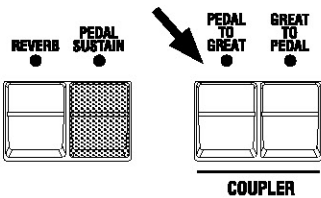

You can play the PEDAL part using the lowest keys of the GREAT manual. This is called “Pedal To Great”.

To use this “Pedal To Great” function, switch the [PEDAL TO GREAT] button “ON.” The LED will light.

When you play the GREAT manual, the lowest note played will sound the PEDAL part. The factory default “Pedal To Great” range is set to “B” of the second octave.

NOTE: You can select whether the GREAT or SWELL Manual will play the PEDAL part (P. 68 #24), as well as move the upper limit. (P. 68 #20, 22)

Great To Pedal

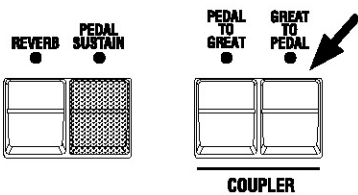

You can play the GREAT Parts using the Pedalboard. This is called “Great To Pedal”.

To use this “Great To Pedal” function, switch the [GREAT TO PEDAL] button “ON.”

When you play the Pedals, the note played will be sounded by the GREAT Part.

The factory default Great To Pedal range is set to “B” of the second octave.

NOTE: You can set the upper key limit of the Great To Pedal. (P. 68 #23)

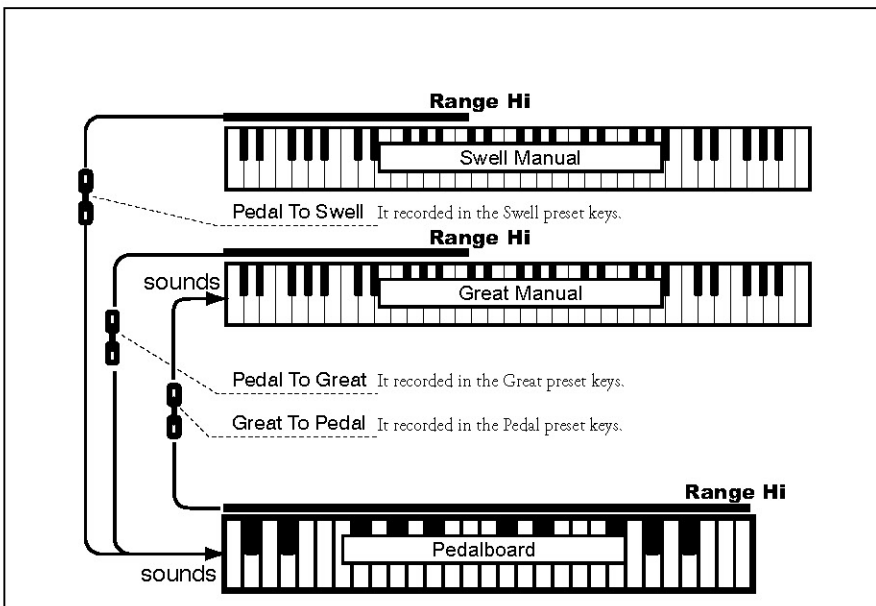

Each coupler functions

Storing registrations to Presets

◆ Ex. Memorize to “F - D” for GREAT part

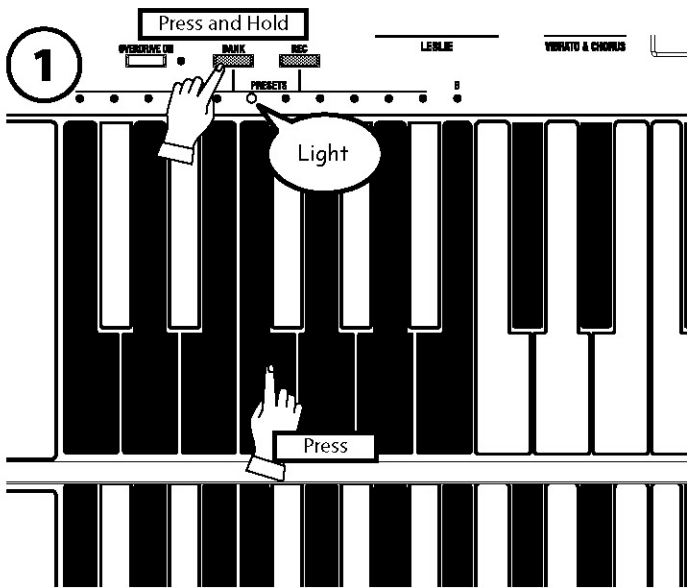

While touching and holding the [BANK] button, press the “F” Preset Key on the SWELL manual.

The LED on the Preset Key indicates BANK while the [BANK] button is touched.

NOTE: The LED goes out if you release the button. This means the Number is not final.

NOTE: You do not need to perform this step if you record the Preset into the current bank.

Power On And Play

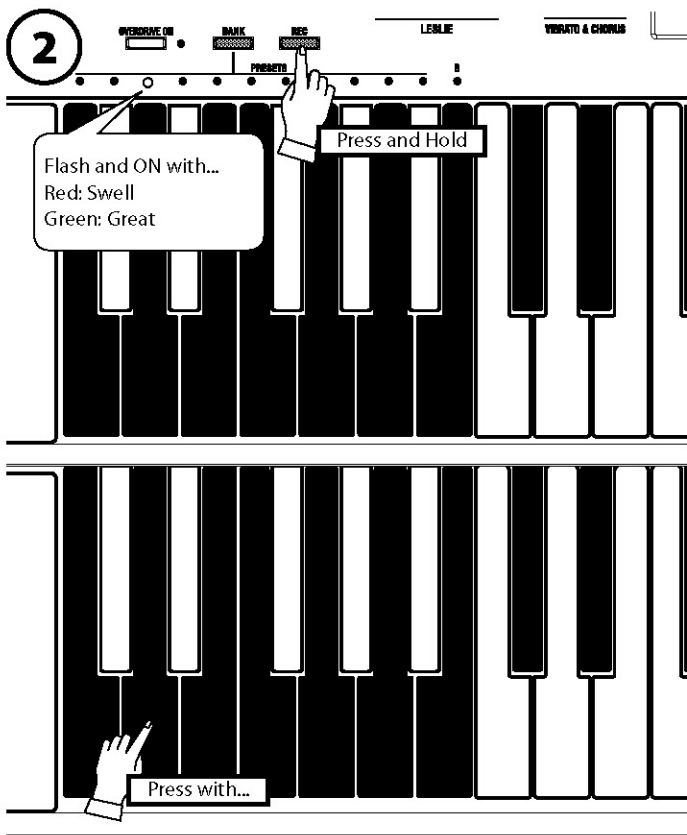

While touching and holding the [RECORD] button, press the “D” Preset Key on the GREAT manual.

The Preset is finalized and “Recording Preset” appears on the Display while the process completes. When the recording is completed, the LED on the “D” Preset Key flashes for a few seconds and then switches “ON.” The Display returns to the previous mode.

The recorded Preset will be automatically selected.

❖ *The “B” or “ADJUST” Preset Key does not record settings using this operation.*

NOTE: The Preset Data is remembered after power off.



SOUND ENGINE STRUCTURE

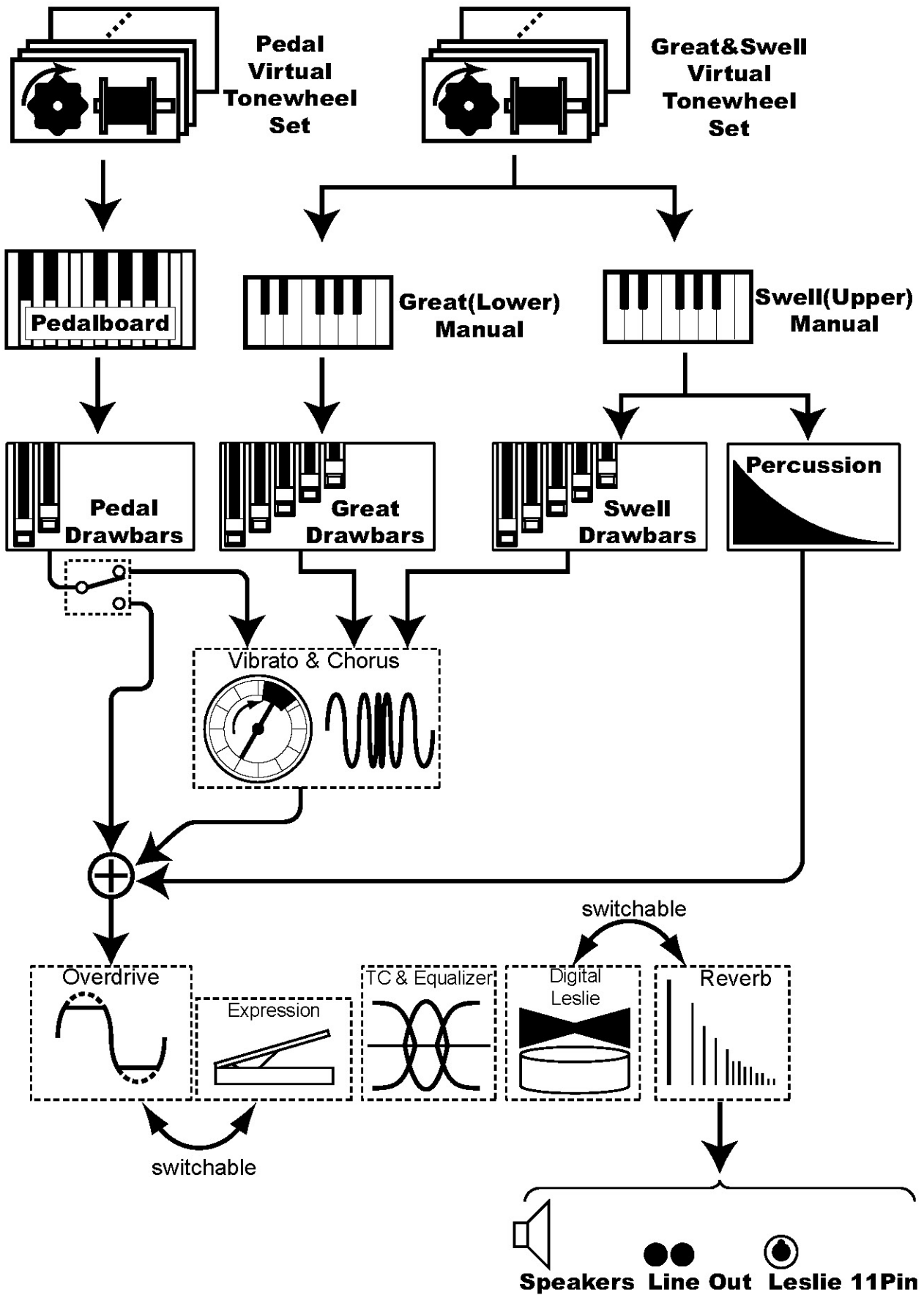

To fully enjoy playing this organ, please read the following section in this manual.

See the system structures of this organ on the left page.

◆ TONE WHEELS

The sound source or “engine” of the Hammond Organ consists of virtual tone wheels, which are like the strings and pick-ups on an electric guitar. While running, each of the 96 virtual tone wheels oscillates at a different frequency.

◆ KEYS

The tone signals created with the 96 virtual tone wheels are “switched” at the keys.

The signals corresponding to the pitch and harmonics (for example, 9 sets on the manual keyboard) are distributed to each key, and when you touch or release a key, the virtual switch connects or cuts the tone signals.

◆ DRAWBARS

The Drawbars select the basic sounds. Each bar adjusts the value of each harmonic.

◆ PERCUSSION

The Percussion adds a sharp accent to the Drawbar sounds. This is the same “Touch-Response Percussion” section as found on the classic B-3/C-3/A-100.

◆ VIBRATO and CHORUS

Vibrato raises and lowers the Drawbar pitch slightly, at an even and adjustable depth and speed. The Chorus combines vibrato and non-vibrato tones. This creates a distinct richness, and is an essential part of the genuine Hammond tone.

The PEDAL part, however, is designed not to pass through the Vibrato & Chorus in order to obtain a clear bass line.

However, you can add Vibrato and Chorus to the PEDAL tones to replicate the Vibrato/Chorus function of the B-3/C-3/A-100.

NOTE: On the classic B-3/C-3/A-100 the chorus/vibrato effect was obtained by an electro-mechanical “scanner”. The A-162 uses a digital model of that scanner that gives an accurate reproduction of the original.

◆ OVERDRIVE

Overdrive adds the fuzzy, raspy, “dirty” sound created by the vacuum tubes of a tube-style Leslie Speaker when its volume is pushed past its sound limit.

◆ EQUALIZER, LESLIE and REVERB

The Organ signal passes through: the Equalizer (for tone regulation), the digital Leslie (for the rotating speaker effects) and the Reverb (for resonance).

If a physical Leslie speaker is connected, the sound of the digital Leslie is output from the built-in speaker, and a “dry” signal is present at the 11-pin socket. This insures that the signal going to the Leslie Speaker cabinet is “clean” - no animation added.

tips TONE WHEEL SET

The tone wheel Sets are divided into the Manual Keyboard and the Pedalboard. This is to give the Pedalboard the Decay (= the sound gradually fading out while pressing the key) or Sustain effect (= the sound gradually fading out after the key is released).

tips HARMONICS

“Harmonics” are tones that are heard in addition to the “fundamental” or basic pitch. On a Hammond organ, the first white Drawbar produces the fundamental tone, while the other Drawbars add harmonics. The more harmonics, the more complex the tone.

HARMONIC DRAWBARS™

The 9 Drawbars for each keyboard (plus 2 for the PEDAL) of the A-162 organ are used to make the basic sounds. If you pull out a Drawbar, you will see a series of numbers appear from 1 through 8. This indicates the volume or loudness of the tone called on by that Drawbar. Each Drawbar has eight degrees of volume or loudness. If the Drawbar is pulled all the way out so that the highest number shown is "8," that Drawbar will be at its maximum volume. If you push the Drawbar in until no numbers show, that Drawbar will be "off" - no sound will be heard.

When a Preset Key ("C#" through "A#") is selected, the Drawbar settings will change, and the settings will be shown in the LCD display. However, the settings of the physical Drawbars are selected by the "B" Preset Key.

If the "C" Preset Key is selected, the Drawbar sounds will be canceled.

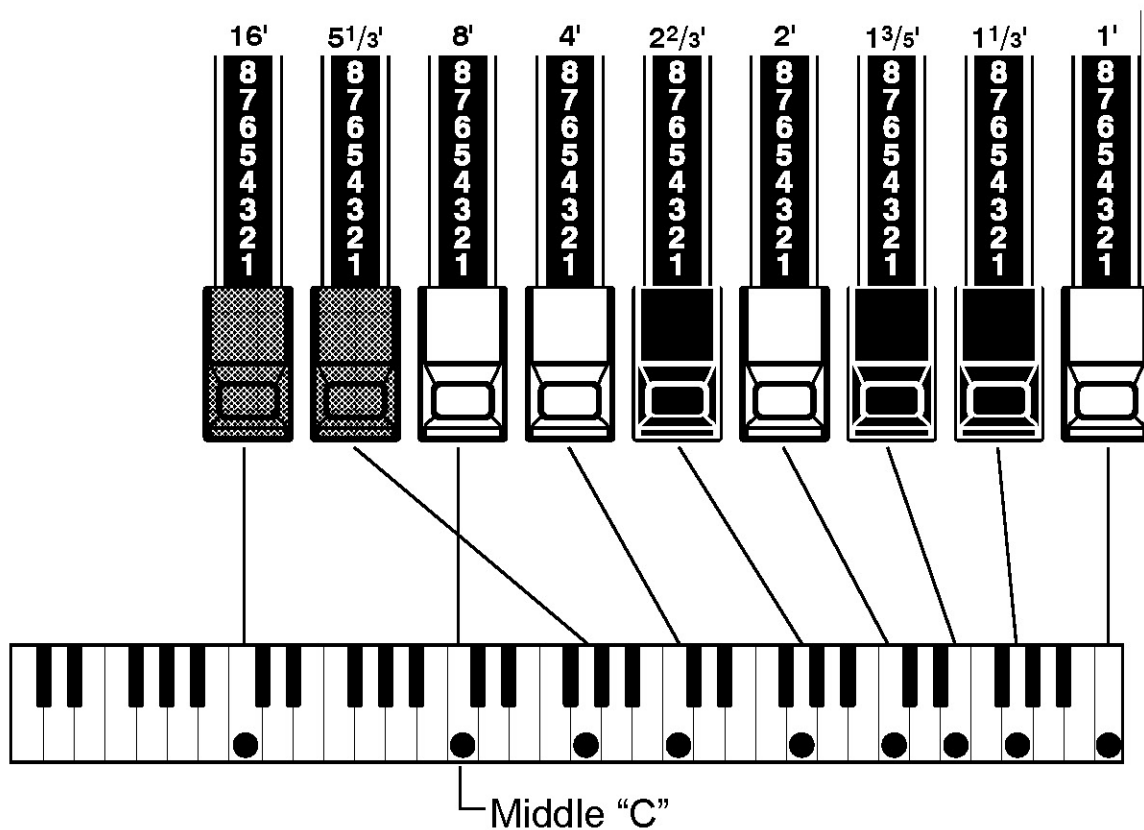

The pitch of each Drawbar is as shown above, when middle C is depressed. The footage marked (') on each Drawbar originated from the length of the pipes of a pipe organ.

For example, when you play a clarinet, the internal air vibrates, and the fundamental (8') the third harmonic (2 2/3') plus the fifth harmonic (1 3/5') are the basic components of the tone. On the A-162 (or any Hammond Organ), if you pull out these 3 Drawbars, you can get a clarinet-like sound. If you pull the 2 2/3' and 1 3/5' Drawbars out all the way and push in the 8' Drawbar slightly, the element of the high pitch increases and a "hard" sound results. Conversely, if you pull out the 8' Drawbar out further and push the 2 2/3' and 1 3/5' Drawbars in slightly, the sound gets mellower.

The millions of combinations possible allow you to make subtle changes to the sound, depending on the flow of the tune or your choice, by fully utilizing the Drawbars.

NOTE: You can change the characteristics of the Drawbars. (P. 62)

Manual Drawbars

◆ White Drawbars

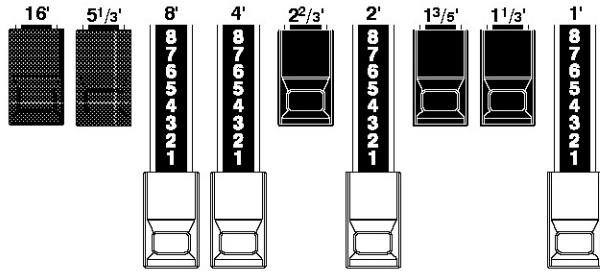

In each Drawbar set, the first white Drawbar (8') plays in the basic octave of the organ. The other Drawbar pitches are figured in reference to this pitch, up or down. The other white Drawbars get higher by the octave to the right.

◆ Black Drawbars

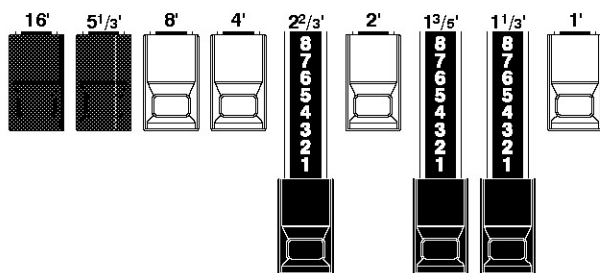

The sounds of the black Drawbars play important roles in building rich tones. Their pitches are octave-fifth and octave-third to the fundamental. They contain the elements of all different harmonics such as those in the sounds of strings, reeds, brasses, etc.

Setting Up

◆ Brown Drawbars

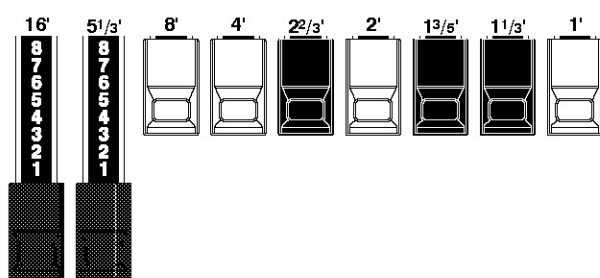

The two brown Drawbars on the far left give depth and richness to the sound. The left 16' is one octave lower than the 8, and 5 1/3' is the third harmonic of the 16' fundamental.

PEDAL Drawbars

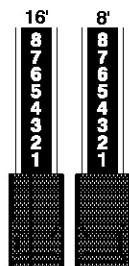

The PEDAL tones are controlled by the two PEDAL Drawbars in the center, marked "16'" and "8'."

The first PEDAL Drawbar produces a tone at 16' pitch for a deep foundation bass, while the second PEDAL Drawbar produces a tone at 8' pitch, or one octave higher.

The registration of the PEDAL part is displayed in the center of the display, the left one is 16', and the right is 8'.

Drawbar Registration Patterns

The Drawbar Registration is matched by numbers. It is easy to remember the typical combinations of the 9 Drawbars by their shapes or patterns.

The Drawbar Registrations are grouped into the following 4 patterns:

◆ Flute family (2 step pattern)

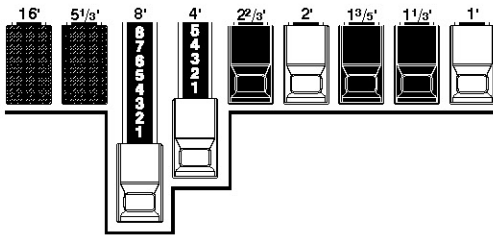

Accompaniment Flute 8' I.....	00 8460 000
Accompaniment Flute 8' II.....	00 3220 000
Accompaniment Flute 8' III.....	00 8600 000
Chorus of Flutes 16'.....	80 8605 002
Orchestral Flute 8'.....	00 3831 000
Piccolo 2'.....	00 0006 003
Stopped Flute 8'.....	00 5020 000
Tibia 8'.....	00 7030 000
Tibia 4'.....	00 0700 030
Tibia (Theater) 16'.....	80 8605 004
Wooden Open Flute 8'.....	00 8840 000

◆ Diapason family (check mark pattern)

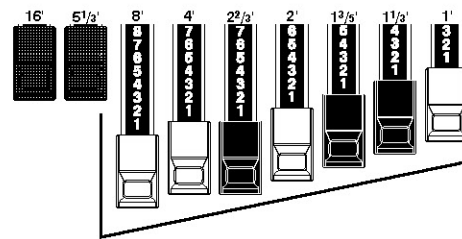

Accomp. Diapason 8'.....	00 8874 210
Chorus Diapason 8'.....	00 8686 310
Diapason 8'.....	00 7785 321
Echo Diapason 8'.....	00 4434 210
Harmonic Diapason 16'.....	85 8524 100
Harmonic Diapason 8'.....	00 8877 760
Harmonic Diapason 4'.....	00 0606 045
Horn Diapason 8'.....	00 8887 480
Open Diapason 8'.....	01 8866 430
Solo Diapason.....	01 8855 331
Wood Diapason 8'.....	00 7754 321

NOTE: Some of the names on this page may be unfamiliar. They represent the names of types of pipes on a pipe organ. The "Diapason" is the fundamental type of pipe on a pipe organ.

◆ Reed family (triangle pattern)

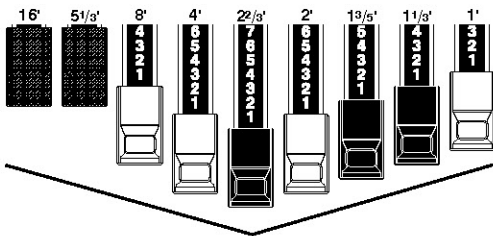

Bassoon 16'.....	44 7000 000
Clarinet 8'.....	00 6070 540
English Horn 8'.....	00 3682 210
Flugel Horn 8'.....	00 5777 530
French Horn.....	00 7654 321
Kinura 8'.....	00 0172 786
Oboe 8'.....	00 4764 210
Trombone 8'.....	01 8777 530
Trumpet 8'.....	00 6788 650
Tuba Sonora 8'.....	02 7788 640
Vox Humana 8'.....	00 4720 123

◆ String family (bow pattern)

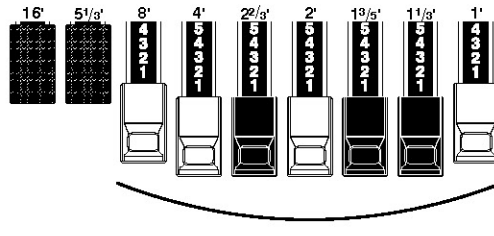

Cello 8'.....	00 3564 534
Dulciana 8'.....	00 7770 000
Gamba 8' I.....	00 3484 443
Gemshorn 8'.....	00 4741 321
Orchestral String 8'.....	00 1464 321
Salicional 8'.....	00 2453 321
Solo Viola 8'.....	00 2474 341
Solo Violin 8'.....	00 3654 324
Viola da Gamba 8'.....	00 2465 432
Violina 4'.....	00 0103 064
Violone 16'.....	26 3431 000

NOTE: The "Strings" and "Reeds" mentioned here are not all analogous to orchestral voices. The names here refer to types of pipes found in a pipe organ and the sounds are not meant to sound as actual violins, trumpets, oboes, etc.

Modern Drawbar Registrations

The Drawbar registrations shown on the previous page are intended to simulate pipe organ registrations since the original intent of the Hammond Organ was to provide a lower-cost alternative to a church pipe organ.

As the Hammond Organ gradually achieved acceptance in other musical fields, such as Pop, Jazz, Rock and Gospel, unique registrations became commonplace.

◆ Jazz

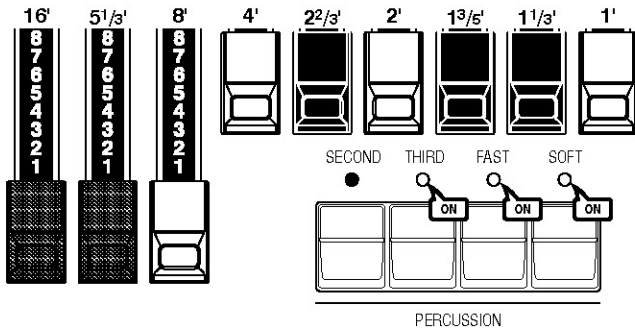

◆ Bluesy

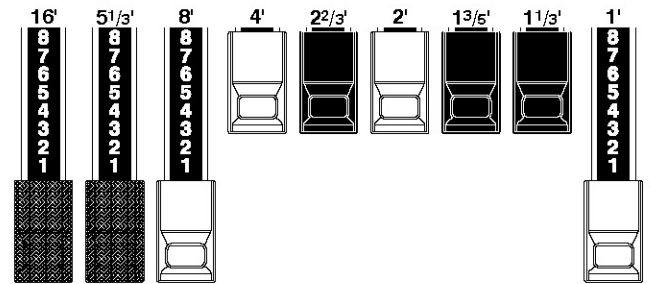

◆ Groovy & Funky

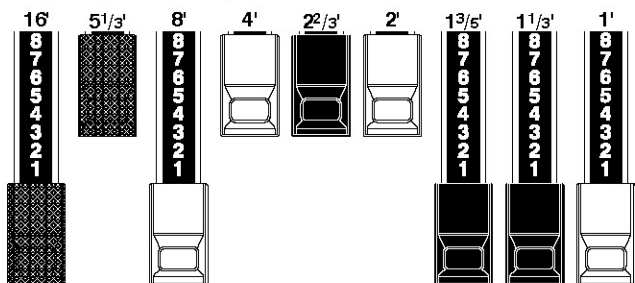

◆ Max Power

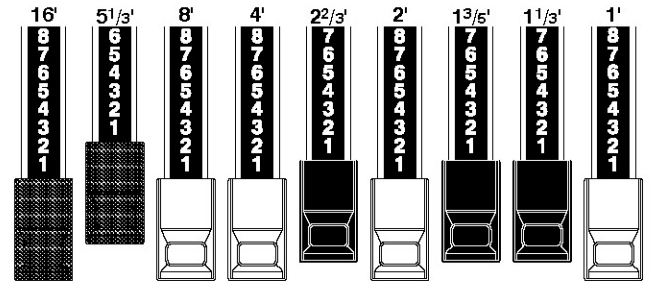

Setting Up

tips APPLICATION OF PERCUSSION

Normally when Percussion is used, the last white Drawbar (1') will be cancelled as it is on a vintage organ. It is possible to override this feature (P. 73 #8); however, many jazz and blues organists leave the 1' Drawbar out all the way and turn the Percussion "on" an "off" to make an instant registration change.

Match the Registration to Drawbars

When you recall a Preset, the Drawbar Registration is not changed physically but is replaced with the one stored in the Preset. If you move any Drawbar at this stage, only that Drawbar will change.

To match the Registration to the Drawbars while a Preset is active, touch and hold the Preset Key for approximately 1 second. The current Drawbar setting will temporarily replace the Preset. If you select another Preset or the "C" Cancel Key and then switch back to the previous Preset, the Drawbar combination stored in the Preset will again play.

The matching function controls the SWELL and GREAT/PEDAL parts independently.

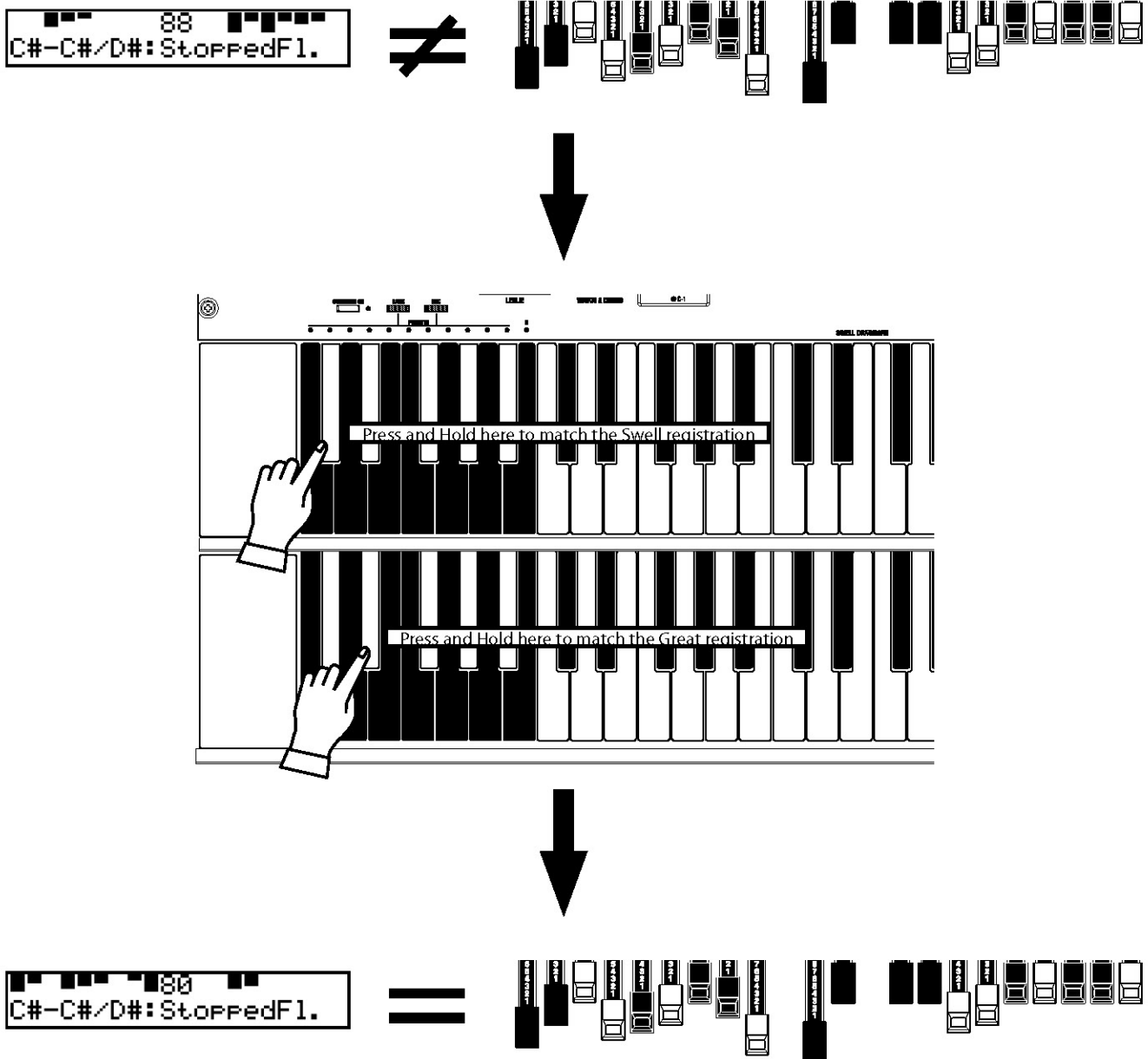

Controlling the Registration while playing a Preset

The A-162 allows you to select whether you want to have active Drawbars on all the Presets or on the "B" Preset only as on a B-3/C-3/A-100.

You can make this selection in the Control Mode portion of the Drawbars - Control Mode. (P. 68 #18)

NOTE: The PEDAL Drawbars are always active regardless of the Preset Key or the GREAT/PEDAL link. (P. 64 #3).

Control Mode = "ONLY [B]"

Controlling the Drawbars...

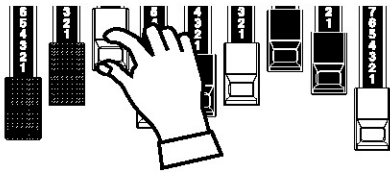

affects only on the [B] "Adjust Preset".

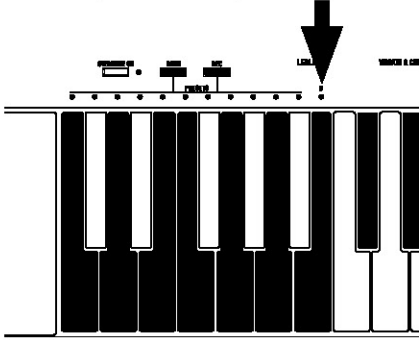

Control Mode = "ALWAYS"

Controlling the Drawbars...

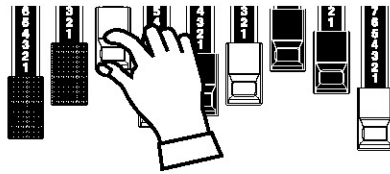

modifies all the Preset Keys.

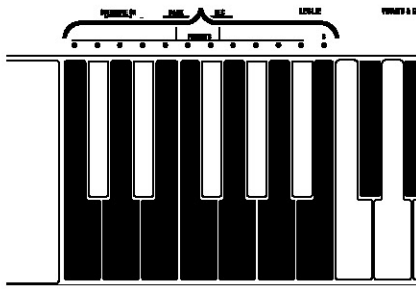

PERCUSSION

The Touch-Response Percussion adds a clear-cut “attack” to the organ sound. It is a Hammond exclusive. Percussion is usually combined with the Drawbar sound.

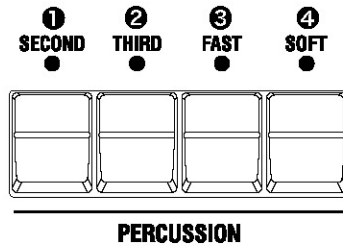

1 [SECOND] button

The second harmonic, or 4' Drawbar decay, is added to the SWELL manual. To use this, touch the [SECOND] button, and the LED will light.

2 [THIRD] button

The third harmonic, or 2 $\frac{2}{3}$ ' Drawbar decay, is added to the SWELL manual. To use this, touch the [THIRD] button, and the LED will light.

3 [FAST] button

This causes the Percussion tones to decay more rapidly. It is effective if you use this to play with a clear-cut rhythm in an up-tempo piece. When the LED is “OFF,” the Percussion Decay is “SLOW.” When the LED is “ON,” the Percussion decays more rapidly (“FAST”).

4 [SOFT] button

This reduces the volume of the Percussion. When the LED is “OFF,” the Percussion volume is “NORMAL.” If you touch the [SOFT] button, the Percussion level is “SOFT,” and the LED will light.

NOTE: You can fine-adjust the levels and decay times of the Percussion. (P. 73)

tips DECAF

A piano's sound gradually decreases in volume when a key is struck and held. This is called “decay”. The violin, on the contrary, keeps sounding at a certain volume. This is called “Sustain”.

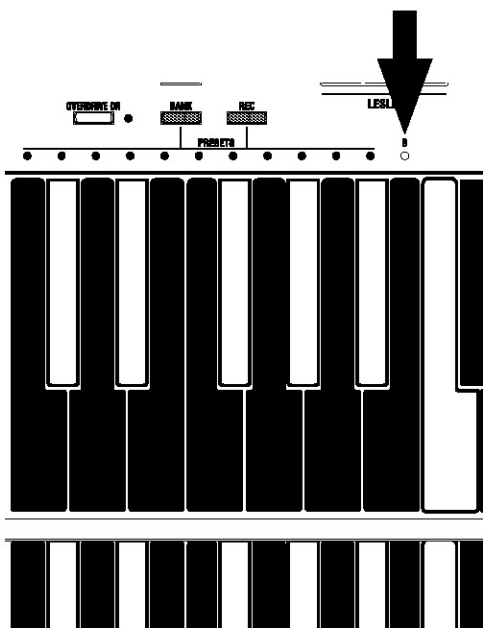

HAMMOND A-162 Owner's Manual

◆ “Percussion does not sound!”

The factory default setting: Percussion does not sound except on the “B” Preset Key, if the “B” Preset Bank is selected (See left figure). This setting is the same as on the B-3/C-3/A-100.

NOTE: You can set any Preset Key to sound Percussion. (P. 64 #7)

◆ Drawbar Cancel

As was the specification on the original B-3/C-3/A-100, when either the [SECOND] or the [THIRD] button is ON, the SWELL 1' Drawbar does not produce sound.

NOTE: The Drawbar Cancel feature can be defeated if you desire. (P. 73 #8)

The VIBRATO gives warmth and variance to the organ's tone by slightly but rapidly raising and lowering the pitch. CHORUS creates the effect of vibrato and non-vibrato tones played simultaneously, giving a "shimmering" sound.

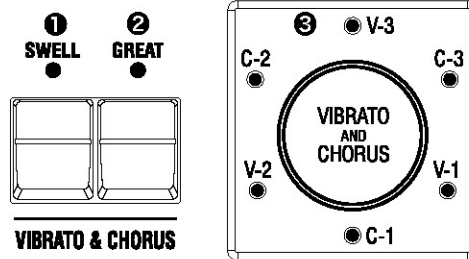

1 [SWELL] button

This switches the Vibrato and Chorus effects for the SWELL Drawbars "ON" and "OFF".

To get this effect, touch the button and the LED will light.

2 [GREAT] button

This switches the Vibrato and Chorus effects for the GREAT Drawbars "ON" and "OFF".

To get this effect, touch the button and the LED will light.

3 [VIBRATO AND CHORUS MODE] knob

This knob controls the depth of Vibrato and switches the Chorus effect "ON" and "OFF".

- V-1: Comparatively slight Vibrato
- V-2: Standard depth Vibrato
- V-3: Deepest Vibrato
- C-1: Comparatively slight Chorus
- C-2: Standard depth Chorus
- C-3: Deepest Chorus

NOTE: While the power is "ON", one of the LEDs of the VIBRATO/CHORUS Rotary Knob is always "ON."

NOTE: You can fine-adjust the Vibrato and Chorus effect (P. 78)

LESLIE

The A-162 features a Digital LESLIE™ system which accurately replicates the sound of the original Leslie Speaker through the A-162's built-in speakers. If desired, a LESLIE™ speaker cabinet may be connected. The controls used for the on-board LESLIE™ system will also control the physical LESLIE™.

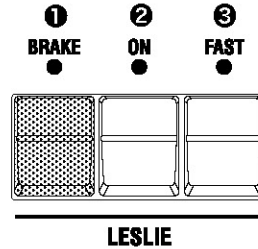

1 [BRAKE] button

This button sets the action when the [ON] button is "OFF."
 When the LED is "ON", the BRAKE mode is active. (= The speed gradually slows down and stops.)
 When the LED is "OFF", the THROUGH mode is active. (= The Leslie effect is by-passed and the voice comes out of the stationary channel.)

2 [ON] button

Routes the Drawbars through the onboard Digital LESLIE system, as well as through a LESLIE cabinet, if connected. When selected, the LED will light.

3 [FAST] button

This toggles the speed of the virtual rotors (or the actual rotors in a Leslie cabinet, if connected) from SLOW to FAST.

NOTE: You can fine-adjust the speeds, etc. of the Leslie effect. (P. 74)

tips BUTTONS AND LESLIE MODES

Button			Mode	
BRAKE	ON	FAST	CH=1	CH=3 & Internal Leslie Effect
ON	ON	ON	Fast	
OFF	ON	ON	Fast	
ON	ON	OFF	Slow	
OFF	ON	OFF	Slow	
ON	OFF	ON	Brake	
ON	OFF	OFF	Brake	
OFF	Off	ON	Fast	Through
OFF	OFF	OFF	Slow	Through

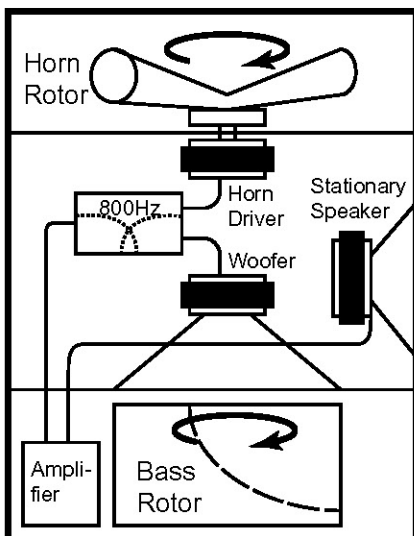

tips WHAT IS THE LESLIE EFFECT?

A traditional single-channel Leslie Speaker (such as a model 122) contains one amplifier and two rotors - the "Horn Rotor" reproduces treble frequencies and the "Bass Rotor" reproduces low frequencies (below 800Hz).

Each Rotor consists of a speaker and a rotating baffle for creating a vibrato or tremulant effect (the "Doppler effect").

In addition to a "Rotary channel," some Leslie Speaker models have one or more additional channels for reproducing non-Drawbar sounds such as piano, strings, etc. These are called "Stationary channels" because they do not use rotors to animate the sound.

The built-in digital Leslie effect on the A-162 will replicate the effect of a single-channel Leslie Speaker or the Rotary channel of a multi-channel Leslie Speaker.

The Overdrive gives distortion to the sound by increasing the pre-amplifier input gain.

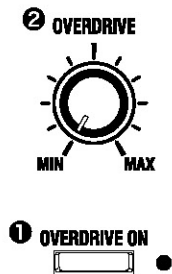

1 [OVERDRIVE ON] button

To hear the Overdrive effect, touch this button and the LED will light.

2 [OVERDRIVE] knob

Adjusts the amount of the Overdrive effect.

Rotating the knob clockwise increases the depth of the effect.

If you open the control panel and it is in the PLAY mode, you will see the amount by bar-graph for a few seconds.



Overdrive is at "75".

NOTE: You can fine-tune the overdrive sound. (P. 78)

TONE

You can adjust the Tone control instantly. The Tone knob controls the built-in 3-band Equalizer and traditional Tone control.

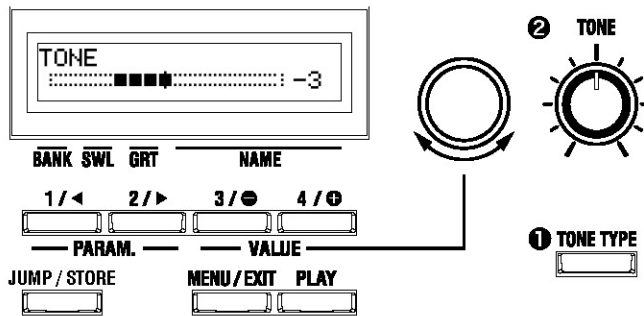

To adjust the Tone, open the lid of the control panel.

1 [TONE TYPE] button

Select the parameter which will be controlled by the [TONE] knob. The parameter changes sequentially by touching this button;

TONE

This models the "screw-set" tone control that was present on the preamp inside of the B-3/C-3/A-100. It gently cuts the treble. The setting range is -9 to +9, and it becomes neutral when set at "0". "-1" corresponds to the maximum of the B-3/C-3/A-100 tone control, "-5", the middle, "-9" the minimum.

BASS

Boosts and cuts the bass range.

MID GAIN

Boosts and cuts the middle range.

TREBLE

Boosts and cuts the treble range.

2 [TONE] knob

Adjusts the value which is selected by [TONE TYPE] button.

While adjusting the Tone control in the PLAY mode, you will see the amount by bar-graph for a few seconds.



Tone is at "-3".

Tone Control

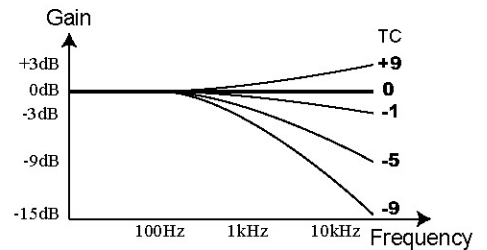

3-Band Equalizer

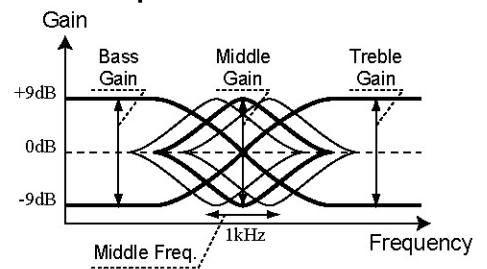

NOTE: You can fine-tune the equalizer. (P. 80)

Many Organists prefer their PEDAL (Bass) voices to smoothly decay in the style of a String Bass. Depressing the [PEDAL SUSTAIN] tab turns this function “ON.” When this function is active, the LED will light.

Some Organists prefer to play the Bass parts on the GREAT manual instead of the Pedals. Depressing the [PEDAL TO GREAT] tab will bring the pedal voice to the lowest range of the GREAT (lower) keyboard. When this function is active, the LED will light.

Some Classical and Sacred music requires a more complex sound to be available on the pedals. Depressing the [GREAT TO PEDAL] tab allows the current registration of the GREAT (lower) manual to be played with the pedalboard. When this function is active, the LED will light.

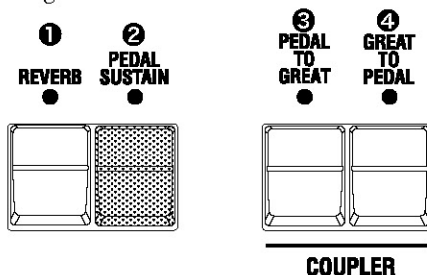

1 [REVERB] button

To get the reverb effect, touch the [REVERB] button and the LED will light.

NOTE: You can fine-control depth, time etc. of Reverb. (P. 81)

2 [PEDAL SUSTAIN] button

The PEDAL Drawbar can be set to smoothly decay after the key is released. This is called “Pedal Sustain”.

To use this function, switch the [PEDAL SUSTAIN] button “ON.” The LED will light.

If you release your foot off the Pedal (or your finger from the GREAT manual, if you are using the Pedal to Great, as explained later in this page), the PEDAL Drawbar sound smoothly decays.

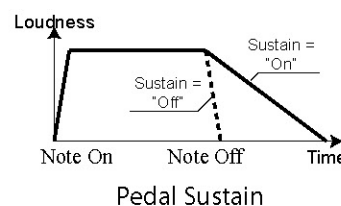

NOTE: You can change the decay time of the Pedal Sustain. (P. 63 #10, 11)

3 [PEDAL TO GREAT] button

You can play the PEDAL part using the lowest keys of the GREAT manual. This is called “Pedal to Great”.

To use the “Pedal to Great” function, switch the [PEDAL TO GREAT] button “ON.” The LED will light.

When you play the GREAT manual, the lowest note played will sound the PEDAL Part.

The factory default “Pedal to Great” range is set to “B” of the second octave.

NOTE: You can select whether the GREAT or SWELL Manual will play the PEDAL part (P. 68 #24), as well as move the upper limit. (P. 68 #20, 22)

4 [GREAT TO PEDAL] button

You can play GREAT part using the Pedalboard. This is called “Great to Pedal”.

To use the “Great to Pedal” function, switch the [GREAT TO PEDAL] button “ON.” The LED will light.

When you play the Pedals, the note played will be sounded by the GREAT part.

The factory default Great to Pedal range is set to “B” of the second octave.

NOTE: You can move the upper limit of the Great to Pedal. (P. 68 #23)

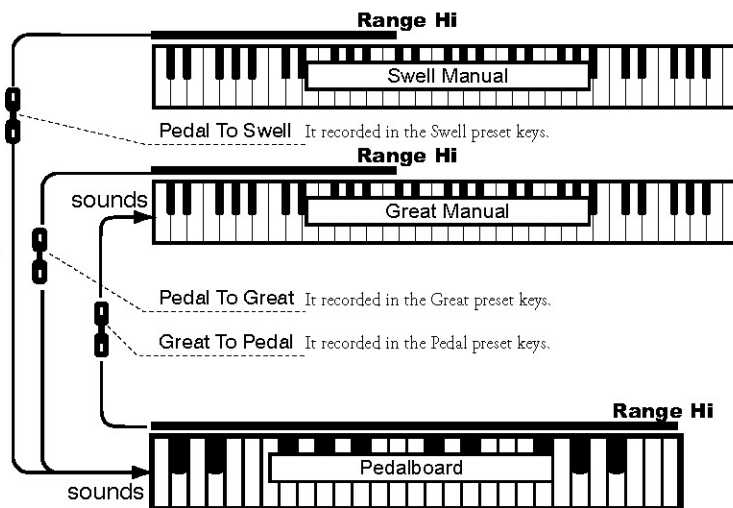

Each coupler functions

The settings you have made can be recorded into the Presets.

Bank and Key

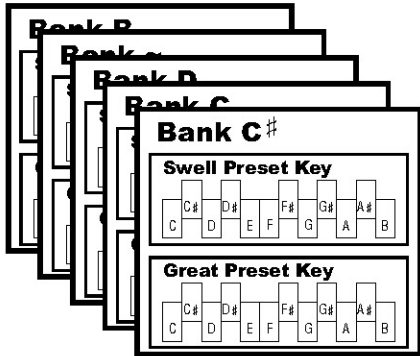

The Preset chart to the left shows the [BANK] and the [KEY], information.

The SWELL and GREAT Presets are independent; however, the Bank is common for both SWELL and GREAT Presets.

Access is made by the Preset Keys. To select the [BANK], touch and hold the [BANK] button and touch the SWELL Preset Key which represents the Bank you want. To select the [KEY], just touch the Preset Key.

Recording and recall is determined when the [KEY] is designated.

Only designating the Bank does not switch the recording or recall.

Detail of the Preset Keys

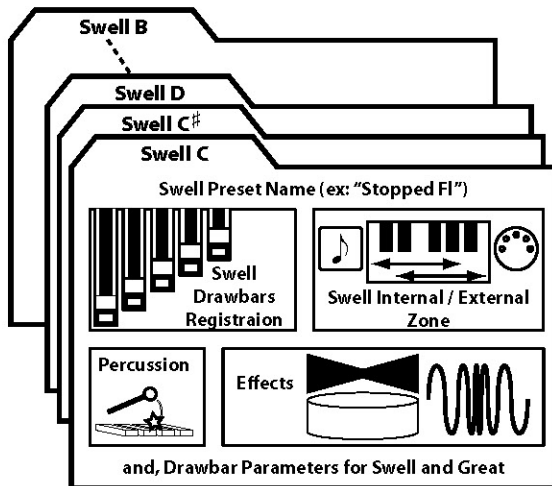

The “B” Preset Key on the right end is called the “Adjust Key”. Here the Drawbar Registration on the panel always matches the internal registration.

NOTE: Only the Drawbar registrations were able to be called on the original B-3/C-3/A-100. The factory settings of this new organ are the same as the factory settings of the original. You can change to call other parameters by the Preset Keys. See the “PRESET” section for details. (P. 64)

If different Preset Keys are selected between the SWELL and the GREAT/PEDAL part, the display/LEDs will look like this.

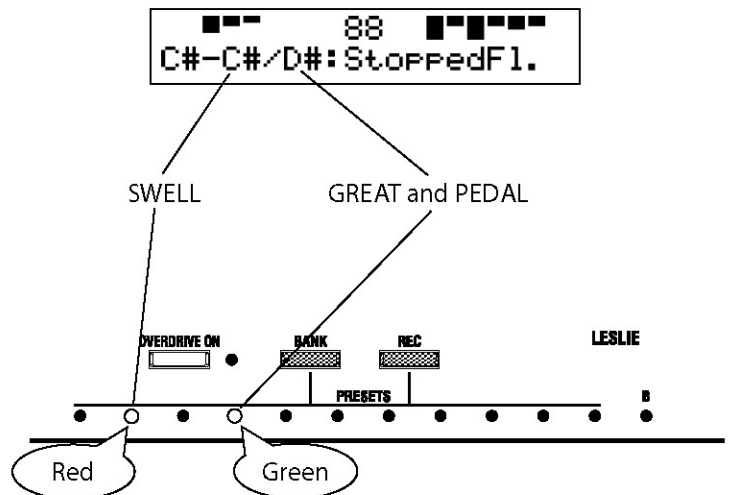
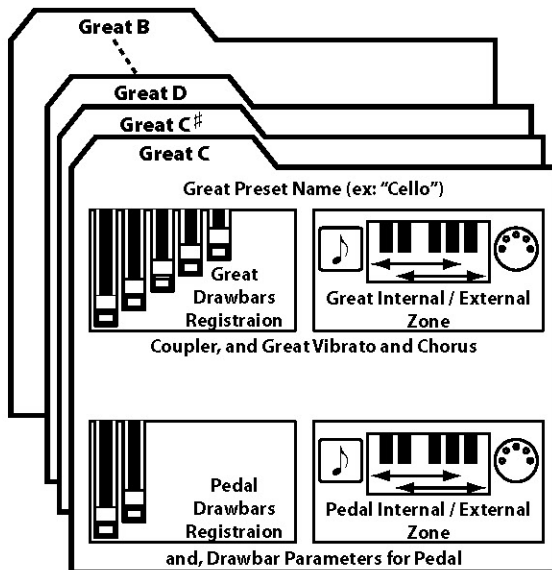

Name the current setting

1 Go to the MENU.

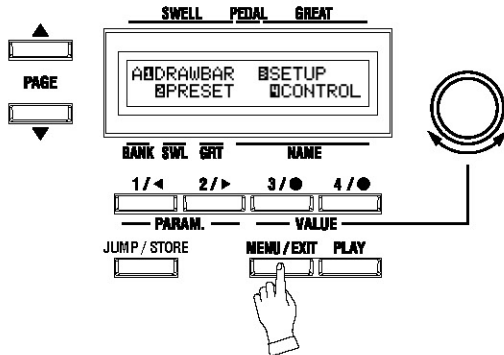

Touch the [MENU] button.
The MENU mode will be displayed.

2 Go to page A.

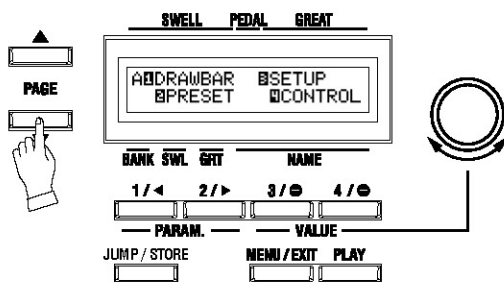

If Page A does not display, touch the [PAGE ▼] button repeatedly until Page A is displayed (see above).

3 Go to the PRESET function mode.

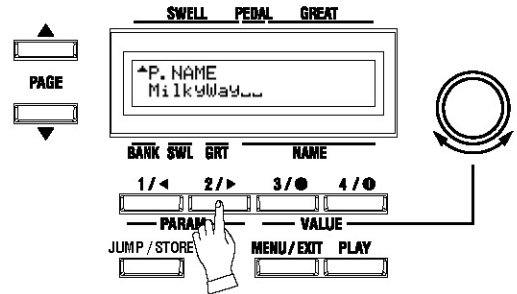

Touch the [2] PRESET button and go to the PRESET function mode.

The first page is for the SWELL name. To input the GREAT name, touch the [▲] button once.

4 Input the NAME.

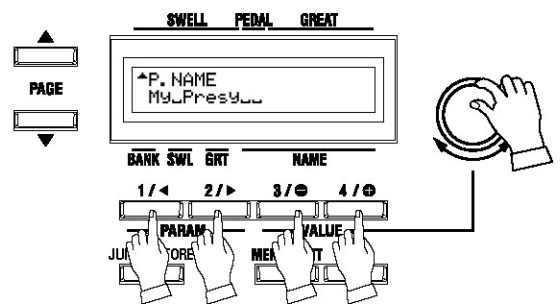

You can store names up to 10 letters.

[PARAM] button: moves the cursor.

[VALUE] button: selects letters.

[VALUE] knob: selects letters.

The available characters include upper- and lower-case letters (A - Z, a - z), numbers (0 - 9) and punctuation marks and symbols.

To jump to the beginning of each list, hold down the [JUMP] button, and touch the [VALUE] button.

NOTE: In order for the name to be remembered, you must save it into the Preset. This is explained on the next page.

Recording your own Presets

Example: Record into "F-D" for the GREAT part

1 Enter the Name

P. NAME
MyPresets

Enter the name for the Combination Preset if necessary. (P. 64 #1)

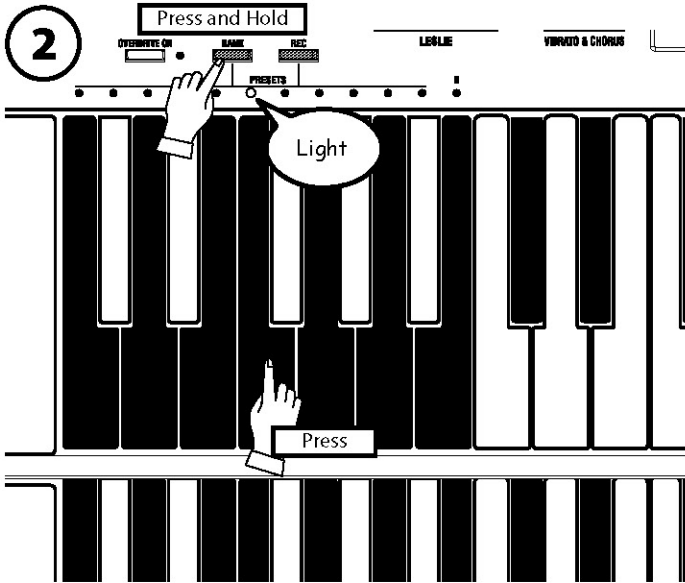

While holding the [BANK] button, touch the "F" Preset Key on the SWELL manual.

The LED on the Preset Key indicates BANK while the [BANK] button is touched.

NOTE: The LED goes out if you release the button. This means the Number is not final.

NOTE: You do not need this step if you record the Preset into the current bank.

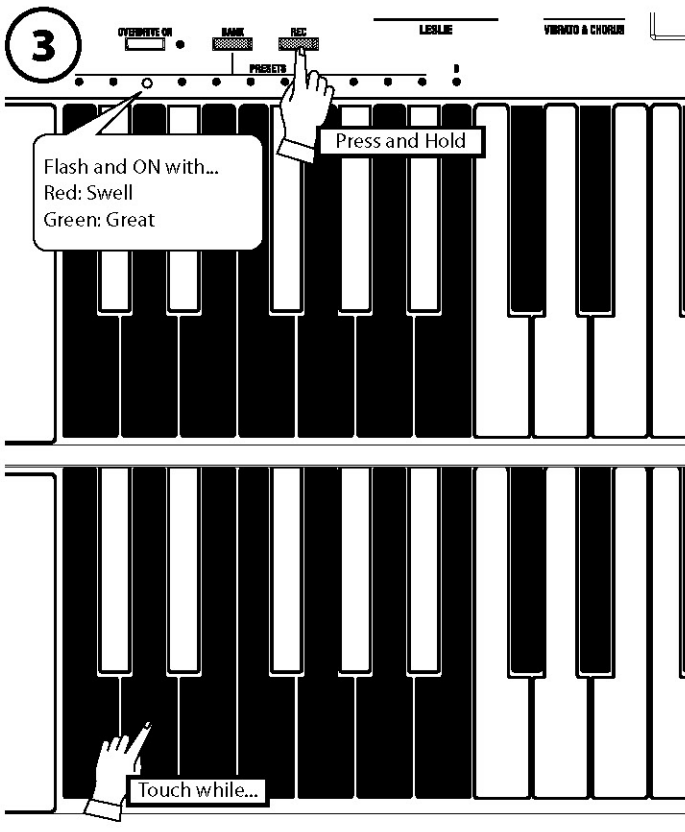

While holding the [RECORD] button, touch the "D" Preset Key on the GREAT manual.

The Preset is finalized and "Recording Preset" appears on the Display while the process completes. When the recording is completed, the LED on the "D" Preset Key flashes for a few seconds and then switches on. The Display returns to the previous mode.

The recorded Preset will be automatically selected.

❖ The "B" or "ADJUST" Preset Key does not record settings using this operation.

NOTE: The Preset Data is remembered when the power to the organ is switched "OFF"

NOTE: On the A-162, all the Preset Keys from "C" through "A#" can memorize registrations. However, it is not recommended that you record a Preset into the "C" key, since that key is normally used to Cancel Drawbar settings as on the vintage B-3/C-3/A-100 organs.

The transpose function allows you to play in one key while the organ sounds in another key. This is helpful if, for example, you need to accompany a vocalist who needs a song in a different key than a printed arrangement.

For example, if you set Transpose at [+5], the note “F” sounds when you play the “C” key. (By playing in the key of C the A-162 sounds in the key of F.)

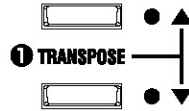

1 [TRANSCOPE] buttons

- To raise the pitch by semitones, touch the [▲] button.
- To lower the pitch by semitones, touch the [▼] button.
- To reset the organ to concert pitch (untransposed), touch the [▲] and [▼] buttons together.

The organ will Transpose up or down by 6 semitones (“-6,” through “+6”).

The [▲] LED lights when the pitch is higher than normal.

The [▼] LED lights when the pitch is lower than normal.



Transpose is at “+5”.

When performing this operation, the status of the transposition is shown in the display.

Transpose is mapped to the following points:

- Between the internal keyboard and the built-in sound engine.
- Between the MIDI IN and the built-in sound engine.
- To the External Zone.

NOTE: The Transpose setting is not memorized - it will reset to “0” when the organ is switched off.



**USING THE
CONTROL
PANEL**

USING THE CONTROL PANEL

The CONTROL PANEL allows the deep editing of the adjustable parameters of the A-162, and shows the status of the organ at any given time. It is the “Nerve Center” of the Organ.

If you raise the lid on the left side just above the 3 Rotary Knobs, you will see the LCD display.

When you first turn the organ “ON,” this display will scroll an introductory message, after which the PLAY Mode will display.

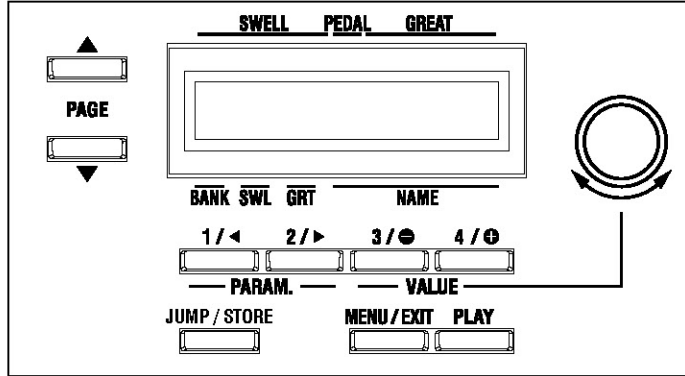

There are PLAY, MENU, and FUNCTION modes in the display.

The buttons and knobs in each mode are explained on the following pages.

PLAY mode

MENU mode

FUNCTION mode

■■■ 88 ■■■■■
C#-C#/D#: StoppedFl.
A DRAWBAR B SETUP
B PRESET C CONTROL
◆ HORN SLOW FAST LEV
SPD 36 393 0 ▶

The PLAY mode is the basic display for normal playing. The necessary information for normal play will be displayed.

There are two types of PLAY mode screens to display the Drawbar Registration.

One is by showing the length of the bars in graphic display and the other by numbers.

To Locate this mode:

1. When the organ is turned "on" and the start up process is complete, the PLAY mode is displayed.
2. If a different mode is displayed, touch the [PLAY] button.

How to read the display

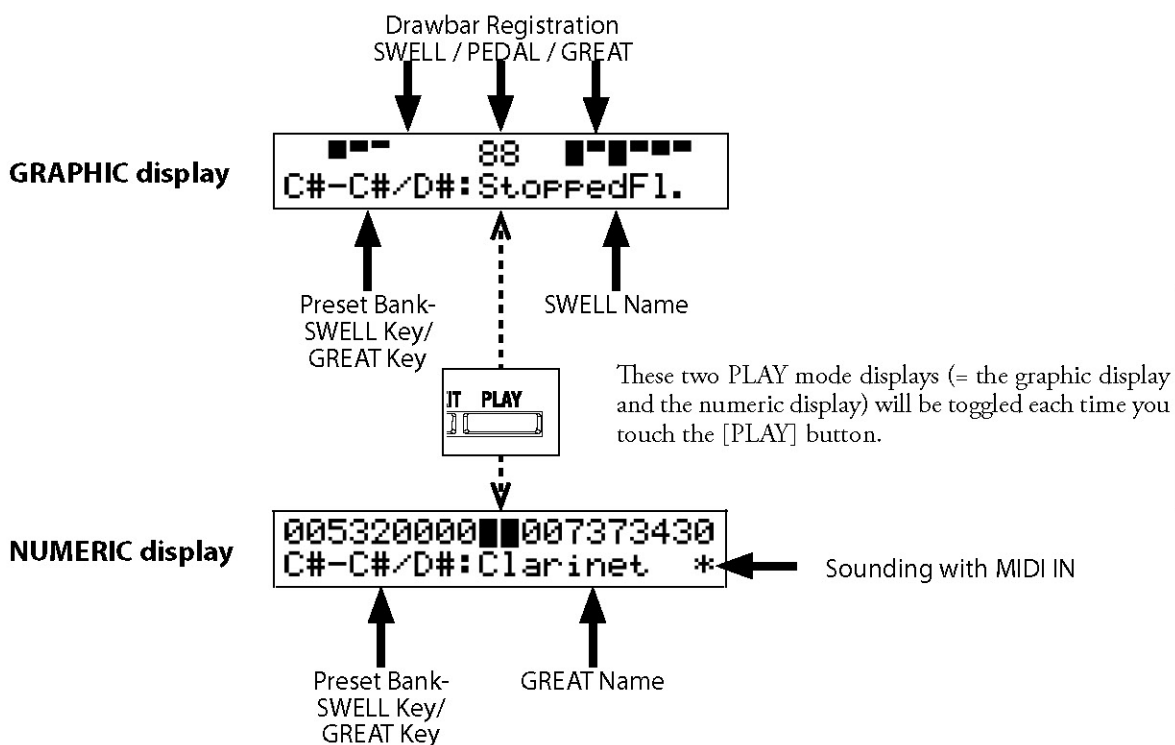

MENU MODE

The MENU mode displays the path for each function.

To locate this mode:

Touch the [MENU/EXIT] button.

There are several pages which contains various FUNCTION displays. Move from page to page to find the item you wish to edit and touch the numbered button to view the desired display.

How to read the display

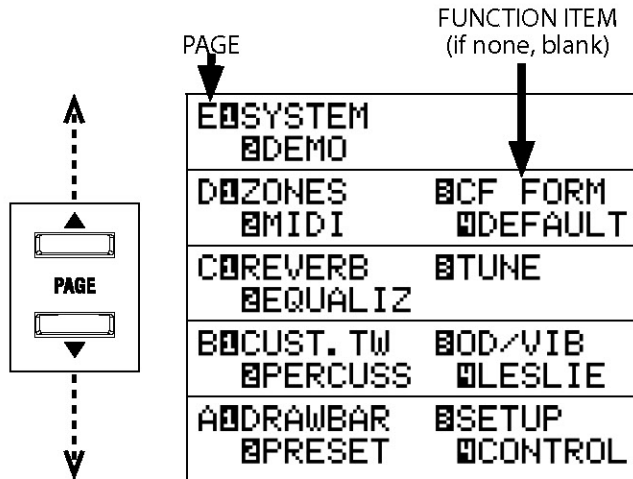

Button operation in this mode

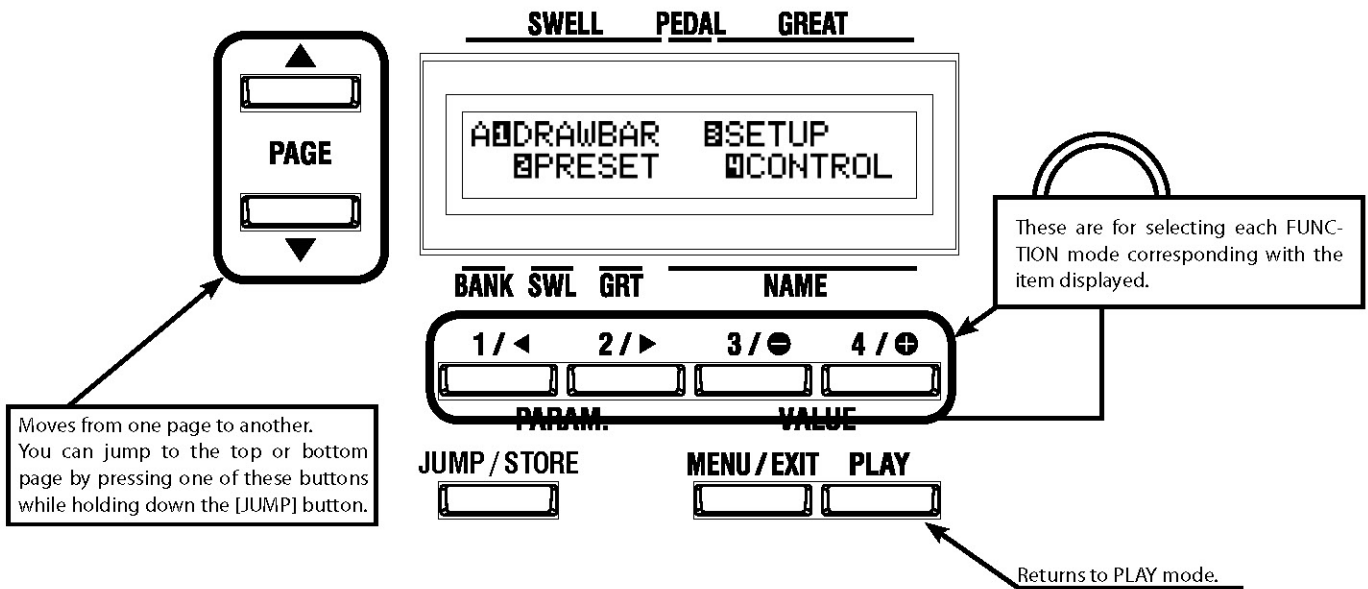

Menus and their contents

Page A

1. DRAWBAR

You can adjust the Parameters relating to the Drawbar sound of each keyboard. (P. 62)

2. PRESET

You can name your Combination Presets and determine how to recall them. (P. 64)

3. SETUP

You can save or load Setups to or from a CompactFlash™ (hereinafter, CF) card. (P. 98)

4. CONTROL

You can modify the Controllers (Expression Pedal, Foot Switch, etc.). (P. 66)

Page B

1. CUST. TW

You can adjust the voicing of the virtual tone wheels of the Manual Drawbars, wheel by wheel. (P. 70)

2. PERCUSS

You can set the parameters of the Percussion sound. (P. 73)

3. OD/VIB

You can change the settings relating to Overdrive and Vibrato/Chorus. (P. 78)

4. LESLIE

You can adjust the settings for the built-in virtual Leslie effect and the control of an External Leslie Speaker. (P. 74)

Page C

1. REVERB

You can adjust the settings for the Reverb effect. (P. 81)

2. EQUALIZ

You can adjust the settings for the Equalizer. (P. 80)

3. TUNE

You can adjust the overall tuning of the A-162. (P. 69)

Page D

1. ZONES

You can adjust the internal and external zones. (P. 92)

2. MIDI

You can adjust the basic MIDI settings. (P. 94)

3. CF FORM

You can format or initialize a CF card. (P. 99)

4. DEFAULT

You can restore the factory default settings of the organ. (P. 82)

Page E

1. SYSTEM

You can adjust the Global System Parameters and the display information. (P. 83)

2. DEMO

You can play the in-built demonstration performances. (P. 23)

FUNCTION MODE

The FUNCTION mode is for making each setting and adjustment. There are many displays, but the basic operation is the same.

How to read the display

This shows there are PAGES above (or below).

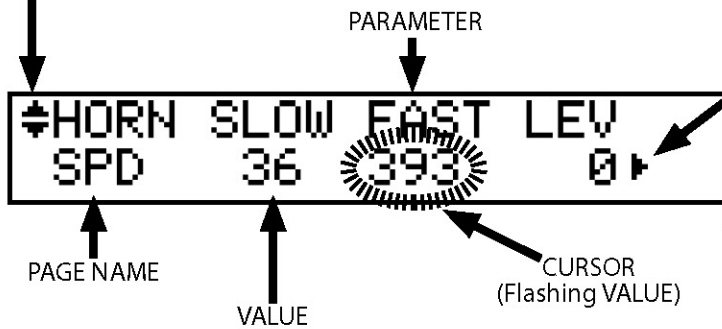

This shows there are PAGES on the right (or on the left).

tips CURSOR

In the display window of this organ, the location of the CURSOR will flash "on" and "off"

Button operation in this mode

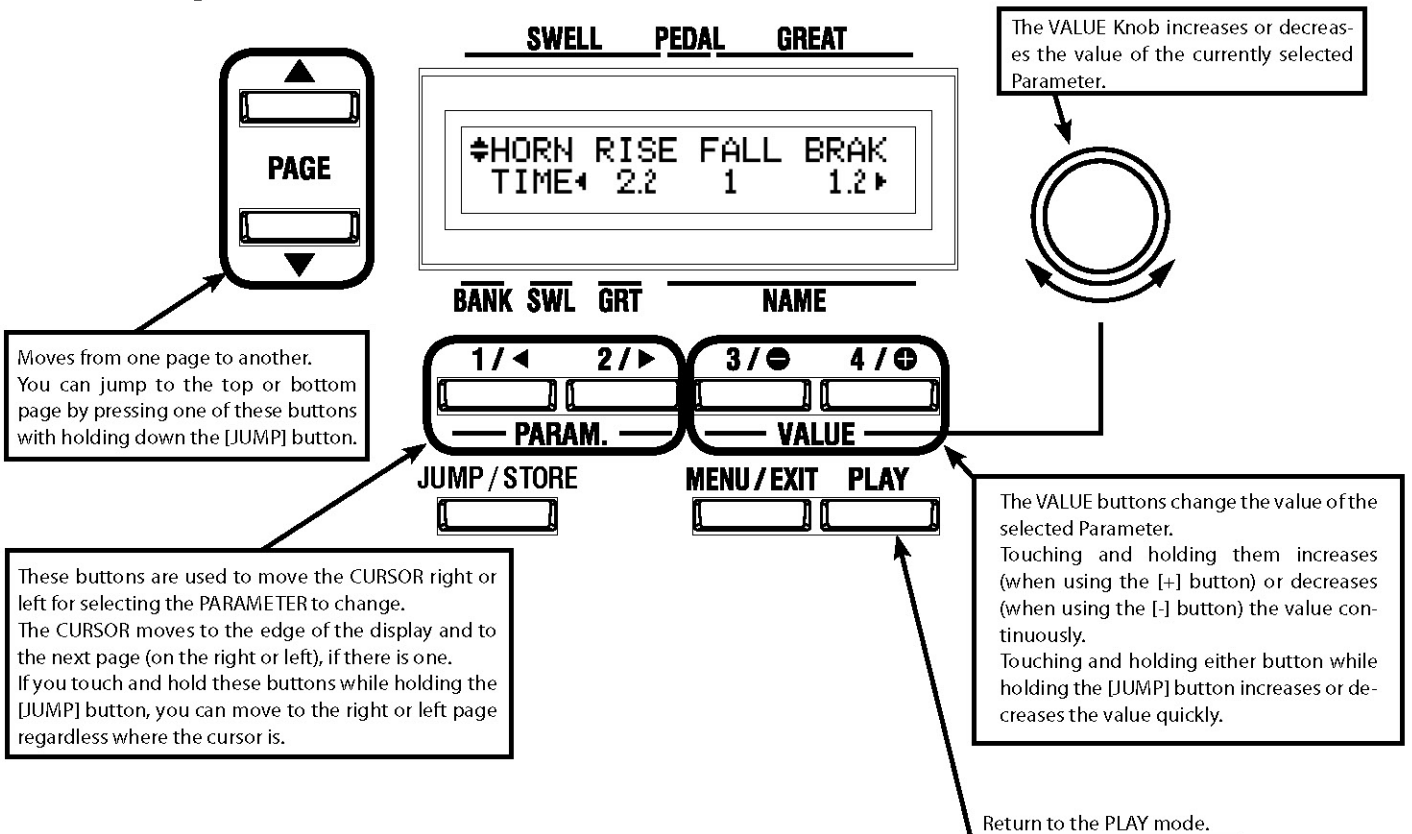

Each button on the panel has a "SHORT-CUT" capability, so that you can easily move to each FUNCTION mode. By holding down the button, you move directly to the desired mode display. You can save time to search the page for the parameters you want to change.

Example of operation:

Move to the Percussion function mode.

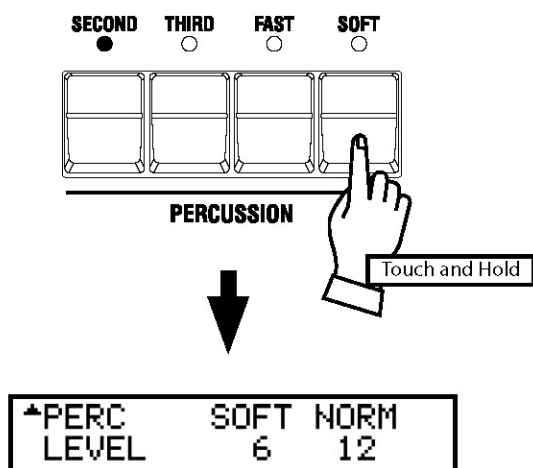

For example, if you wish to "SHORT CUT" to the Percussion setting, by hold down either [SECOND], [THIRD], [DECAY] or [SOFT] for approximately 1 second.

Short-cut buttons will be explained in the next Chapter "SETTING THE PARAMETERS".

NOTE: You can change the time for holding down the button for "SHORT CUT". (P. 67 #16)

Example of operation:

◆ Adjusting the DECAy TIME of the Percussion [FAST]

1 Go to the MENU mode.

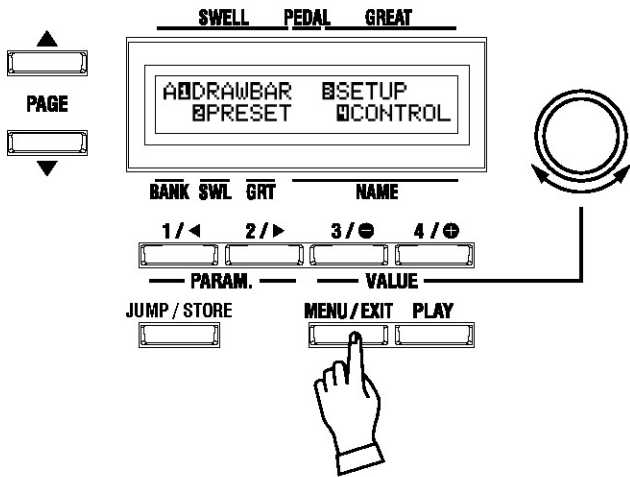

Touch the [MENU] button.
The MENU mode is displayed.

2 Select the PAGE.

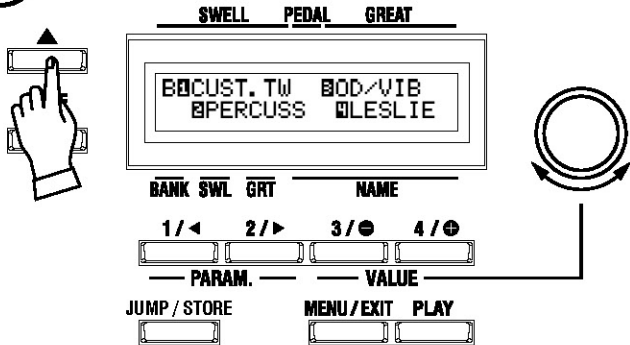

Search for the PERCUSS page, using the [PAGE] button.
“PERCUSS” is on page B. Select page [B].

3 Select the menu item.

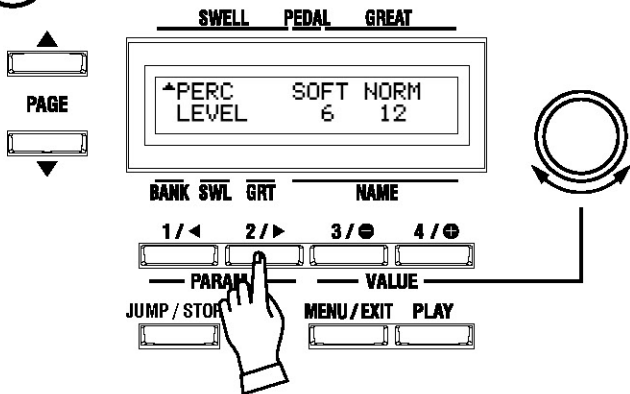

Touch the [2] button for “PERCUSS”.
Now you are on the first page of the Percussion function display.

4 Move the CURSOR to the Parameter you want to change.

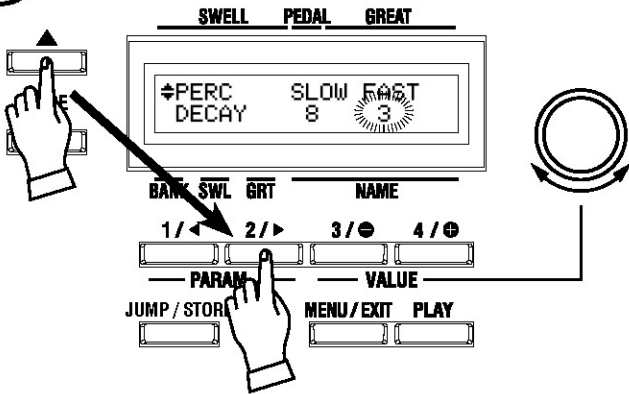

DECAY TIME is on the “DECAY” page. Move to that page using the [PAGE] button.

“FAST” is on the right side of the display. Move the CURSOR (flashing value) to “FAST” using the [PARAM] button.

5 Change the value.

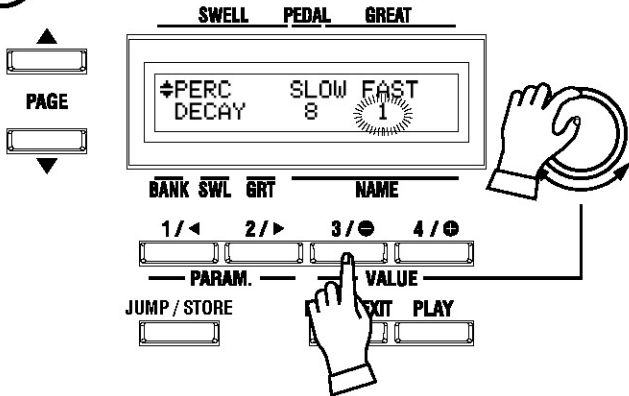

Decrease the value, using the [VALUE] button or [VALUE] knob.

NOTE: Repeat the operation 1 - 5, if you also wish to change the other parameters.

6 Record into a Preset.

Changes to this or any other Preset Parameters are temporary unless saved into a Preset.

If you want to continue to use the changed value hereafter, record the value into a Preset.

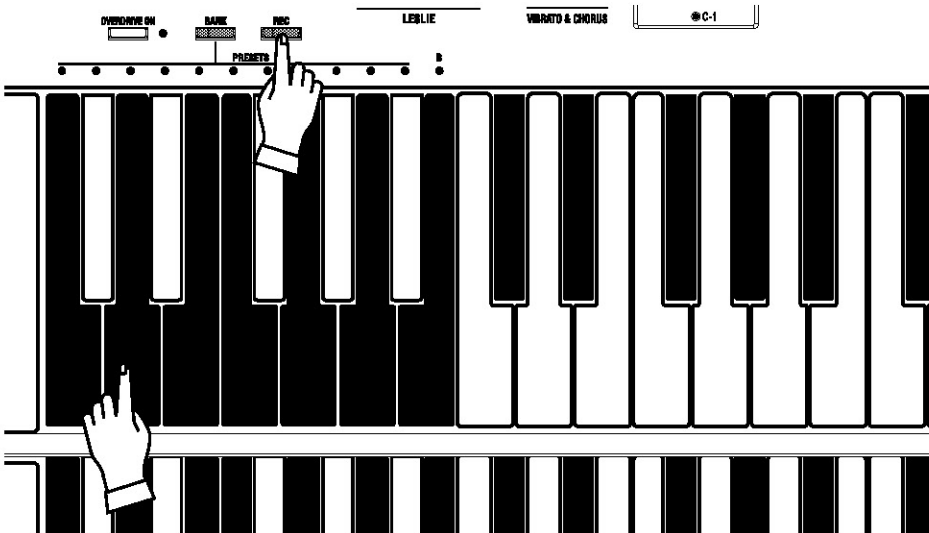

tips PRESET PARAMETERS

Preset Parameters are the Parameters to be recorded into each Preset.

They include the Parameters for setting the status of the buttons/knobs on the panel, such as “Decay Fast” and many others.

The general common Parameters (which are not included in the Presets) are called “Global Parameters”.

LOCK THE DISPLAY IN PLAY MODE

This advanced feature allows you to put the organ into a special playing mode whereby the Control Panel is rendered inoperative. Touching any of the MENU Touch Buttons will have no effect. This is useful when you want to place the organ in public halls, churches or auditoriums.

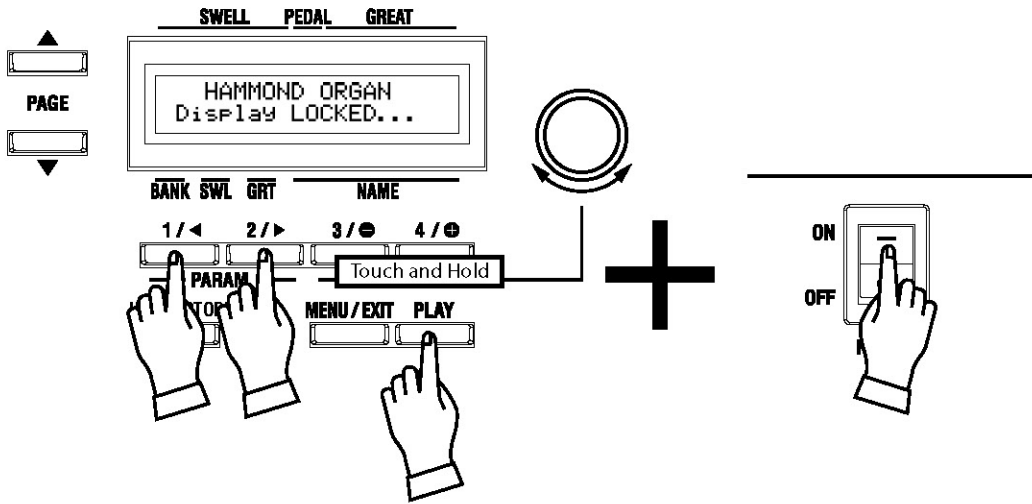

To initiate the Display Lock function, switch the power "ON" touching and holding both PARAM [◀], [▶] buttons and the [PLAY] button together. "Display LOCKED..." will be displayed for a few seconds. To unlock it, do the same thing as above. This time "Display UNLOCKED.." will appear for a few seconds.

NOTE: You can record Presets, as well as use the Transpose, Tone control and Overdrive functions while the Display Lock function is active.

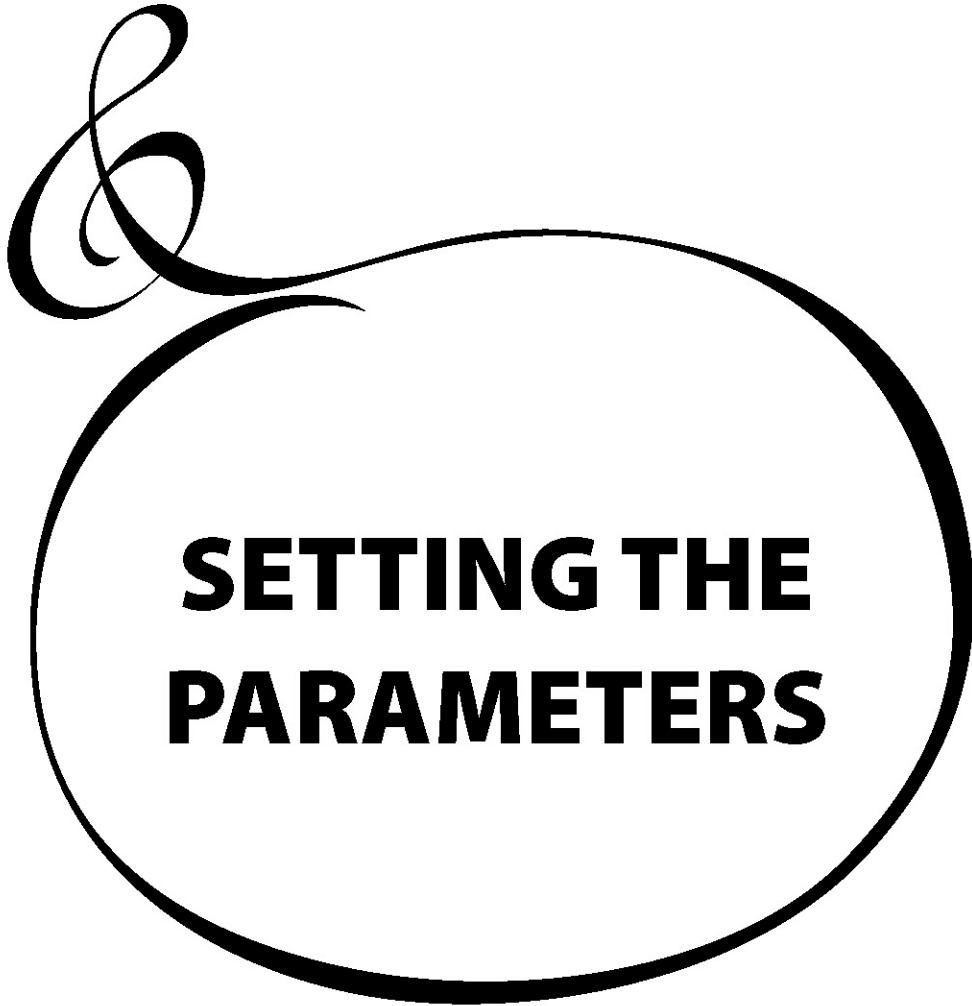
A decorative graphic consisting of a large, stylized ampersand (&) on the left, which curves into a large, thick-lined circle on the right. The circle contains the text "SETTING THE PARAMETERS" in a bold, sans-serif font.

**SETTING THE
PARAMETERS**

DRAWBAR

In this mode, you can set the Parameters relating to the Drawbar sound of each keyboard.

To locate this mode:

1. From either of the PLAY screens, touch the [MENU/EXIT] button. Menu A will display.
2. Touch the [1] DRAWBAR button.

↘PEDAL ATTACK Muted 7 NORM CLK 8	↘PEDAL DECAY SUS VEL Muted 9 CONT 10 3 11 OF	↘PEDAL MODE Muted 12 POLY
^S&G CLK AT-RL LPF BType1 1 2 8 3 8 4 115	^S&G LO-FOLD-HI BType1 4 2C 5 6 4G	

◆ MANUAL DRAWBARS (SWELL and GREAT)

① TONE WHEELS (P)

Select the virtual tone wheel set (waveform) for the manual Drawbars.

BType1: The traditional tone wheel sound of the B-3/C-3/A-100.

BType2: This sound includes more leakage noise and flutter.

Mellow: Transparent sine wave.

Brite: The analog-oscillating sound of the vintage Hammond X-5.

Saw: Sawtooth waveform (Non-Hammond "Combo Organ" Style).

② CLICK - ATTACK LEVEL (P)

The higher the value, the louder the click volume. At 4 no key click is heard. Also, when the value is below 4, the attack speed of the Drawbar voices slows.

③ CLICK - RELEASE LEVEL (P)

The higher the value, the louder the click volume. At 4 no key click is heard. Also, when the value is below 4, the release rate slows.

④ CLICK - LPF (P)

This allows you to set the tone of the Key-Click.

The setting range is 0 - 127. The larger the value, the brighter the Key-Click.

⑤ FOLD-BACK - LOW (P)

This allows you to set at which key the 16' Drawbars starts to FOLD-BACK (repeat the same notes in a higher octave on the keyboard).

The first key (= the far left playing key on the manual) is displayed as "1C". The setting range is 1C - 2C.

⑥ FOLD-BACK - HIGH (P)

This allows you to set at which key the 1' Drawbar starts to FOLD-BACK (repeat the same notes in a lower octave) in the upper-most range. The set range is 4G - 5C.

NOTE: The FOLD-BACK sets not only the 1' but also the 1½', 1¾', 2' and 2½' Drawbars.

tips TONE WHEEL SET

Each tone wheel set allow you to make fine adjustments. (P. 70)

tips KEY-CLICK

The "Key Click" is the noise heard every time the key is touched or released on the B-3/C-3/A-100, as the voice is generated by mechanically switching the key contacts. The function on this model simulates the Key Click.

Loudness

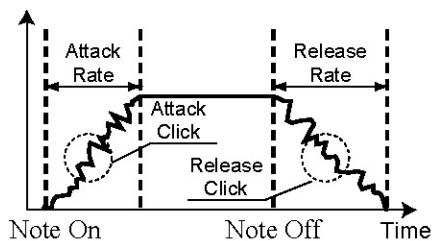

tips EXAMPLES OF KEY CLICK SETTINGS

Simulating the multi-contact keyboard represented by the B-3/C-3/A-100: AT=8, RL=8

Simulating a PCM synthesizer where only the Attack produces a Key Click: AT=8, RL=4

Simulating the quieter key contact system represented by the X-66: AT=4, RL=4

The slow envelope like the pipe organ: AT=0, RL=0

tips FOLD-BACK

As the number of the tone wheels was limited on the B-3/C-3/A-100, the organs were designed to repeat the same octave in the upper-most and lower-most range. This feature reproduces this characteristic.

◆ PEDAL DRAWBARS

7 TONE WHEELS (P)

This allows you to select the tone wheel set (waveform) of the PEDAL Drawbars.

- Normal:** The traditional B-3/C-3/A-100 tone wheel sound.
- Muted:** Analog-oscillating sound represented by the vintage Hammond X-5.
- Synth1:** Sawtooth waveform with sweep filter.
- Synth2:** Dull square waveform.

8 ATTACK (P)

This allows you to set the Attack Rate and the Key-Click Volume at ATTACK and RELEASE.

- MAX CLK:** Immediate attack and the key-click is loud.
- NORM CLK:** Immediate attack and the key-click is normal.
- SOFT CLK:** Immediate attack and the key-click is soft.
- NO CLK:** A slightly slower attack without key-click.
- SLOW ATK:** Slow attack without key-click.

9 DECAY RATE (P)

This allows you to determine whether the PEDAL voice remains at the same volume as a note is held, or if the voice decays, as a plucked string.

The setting range is 1 - 5 and C. The higher the value, the longer the decay time. There is no decay at C.

10 SUSTAIN LENGTH (P)

This allows you to set the Release Rate (= the decay time after you release the pedal), when the [PEDAL SUSTAIN] button is ON.

1 is the shortest, and 5 is the longest decay time.

NOTE: You can locate this page by holding down the [PEDAL SUSTAIN] button as well.

11 VELOCITY (P)

This allows you to set the response to the Velocity. The setting range is OF and 1 - 4. At OFF, the volume does not change however hard you play the key. As the value increases from 1 - 4, the sounds gets louder even if the key is played softly.

NOTE: This parameter is enabled only when using the [PEDAL TO GREAT] or [PEDAL TO SWELL] function. The pedalboard of this organ has no velocity sensor.

12 PEDAL - KEY MODE (P)

This allows you to set the PEDAL voice mode.

- POLY:** Makes it possible to play harmony (up to 8 notes).
- MONO:** Only one note sounds. If multiple notes are played, only the last note depressed will sound.

NOTE: When [PEDAL SUSTAIN] is "ON," each new note played will cancel the previous note. This is so that the pedal tones will not overlap and "bleed into" each other.

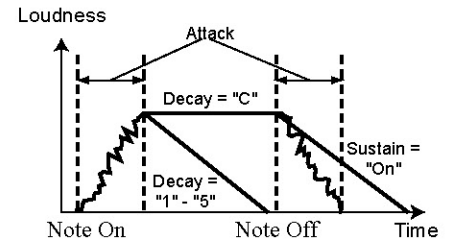

tips SUSTAIN

In organ terminology, unlike Synthesizer nomenclature, the word "Sustain" refers to note decay after note release. On a synth envelope generator this setting would be called "T4" or "Release".

NOTE: All the parameters in these modes (P) are Preset Parameters. They are recorded into the Combination Preset.

PRESET

In this mode, you can name your Presets and determine how to recall them.

To locate this mode:

1. From either of the PLAY screens, touch the [MENU/EXIT] button. Menu A will display.
2. Touch the [2] PRESET button.

▾P. BANK INT. Z EXT. Z MIDI Tx 18 OFF 19 OFF	⚡P. LOAD SWL GRT PED REGIST 3 ON 4 ON 5 ON ▸	⚡P. LOAD S&G PED PERC DB/PC 6 OFF 7 OFF 8 OFF ▸	⚡P. LOAD OD ANI EORV EFFECT 9 OFF 10 OFF 11 OFF ▸
⚡P. NAME GREAT 2 Cello_			
⚡P. NAME SWELL 1 StoppedFl.			

◆ PRESET NAME

① PRESET NAME - SWELL (P)

This allows you to name the present SWELL Preset using up to 10 letters.

Move the cursor by the [PARAM] button, and choose the letters by the [VALUE] button.

This change will be lost if you do not record it, the same as the other Preset Parameters.

② PRESET NAME - GREAT (P)

This allows you to name the present GREAT Preset using up to 10 letters.

NOTE: The parameters followed by a (P) are Preset Parameters, and are recorded to each Preset Key.

◆ PRESET LOAD

This allows you to choose the operation of the Preset Keys.

③ PRESET LOAD - SWELL REGISTRATION (B)

This is for setting whether or not to call out the registration of the SWELL manual by the SWELL Preset Key.

④ PRESET LOAD - GREAT REGISTRATION (B)

This is for setting whether or not to call out the registration of the GREAT manual by the GREAT Preset Key.

⑤ PRESET LOAD - PEDAL REGISTRATION (B)

This is for setting whether or not to call out the PEDAL registration by the GREAT Preset Key.

⑥ PRESET LOAD - SWELL AND GREAT DRAWBAR (B)

This allows you to determine whether or not to recall the Parameters relating to the Drawbars of each keyboard, by a SWELL Preset Key.

⑦ PRESET LOAD - PEDAL DRAWBAR (B)

This allows you to determine whether or not to recall the Parameters relating to the PEDAL Drawbars by a GREAT Preset Key.

⑧ PRESET LOAD - PERCUSSION (B)

This allows you to determine whether or not to recall the Parameters relating to the Percussion by a SWELL Preset Key.

When this parameter is "OFF," the Percussion tones will only sound when the SWELL "B" Preset Key is selected. This replicates the Percussion function of the vintage B-3/C-3/A-100.

⑨ PRESET LOAD - OVERDRIVE (B)

This allows you to determine whether or not to recall the Parameters relating to the Overdrive by a SWELL Preset Key.

tips NO RECORD/SAVE OPTIONS

The Preset Load options filters the parameters if the Preset is recalled.

All the SWELL (or GREAT and PEDAL) parameters are saved on the Preset record operation.

tips

WHERE ARE THE PEDAL PARAMETERS SAVED?

The Preset parameters for the PEDAL part are recorded into the GREAT Preset Keys.

†P. LOAD SWL GRT PED INT. Z †ON ⑫ ON ⑭ ON †	†P. LOAD SWL GRT PED EXT. Z †ON ⑮ ON ⑰ ON †
--	--

⑩ PRESET LOAD - ANIMATION (B)

This allows you to determine whether or not to recall the Parameters relating to the Vibrato and Chorus, and Leslie effects by a SWELL Preset Key, and Vibrato and Chorus for GREAT manual by a GREAT Preset Key.

⑪ PRESET LOAD - EQUALIZER / REVERB (B)

This allows you to determine whether or not to recall the Parameters relating to the Equalizer and Reverb by a SWELL Preset Key.

⑫ PRESET LOAD - INTERNAL ZONE SWELL (B)

This allows you to determine whether or not to recall the Parameters relating to the SWELL key range and octave by a SWELL Preset Key.

⑬ PRESET LOAD - INTERNAL ZONE GREAT (B)

This allows you to determine whether or not to recall the Parameters relating to the Couplers such as [PEDAL TO GREAT], GREAT key range and octave by a GREAT Preset Key.

⑭ PRESET LOAD - INTERNAL ZONE PEDAL (B)

This allows you to determine whether or not to recall the Parameters relating to the Couplers such as [GREAT TO PEDAL], PEDAL key range and octave a the GREAT Preset Key.

⑮ PRESET LOAD - EXTERNAL ZONE SWELL (B)

This is for setting whether or no to call out the External Zone Parameters of the SWELL manual by a SWELL Preset Key.

⑯ PRESET LOAD - EXTERNAL ZONE GREAT (B)

This is for setting whether or not to call out the External Zone Parameters of the GREAT manual by a GREAT Preset Key.

⑰ PRESET LOAD - EXTERNAL ZONE PEDAL (B)

This is for setting whether or not to call out the External Zone Parameters of the Pedals by a GREAT Preset Key.

◆ PRESET BANK

⑱ PRESET BANK - TRANSMIT INTERNAL ZONES (B)

This is for setting whether or not to send the playing information related to Internal Zones (or, keyboard channels) such as SWELL, GREAT, PEDAL Drawbar and Leslie control.

⑲ PRESET BANK - TRANSMIT EXTERNAL ZONES (B)

This is for setting whether or not to send the playing information related to External Zones such as SXZ, GXZ, and PXZ of page 92.

NOTE: The Parameters followed by a (B) are Bank Parameters. They are set only for the BANK currently selected.

CONTROL

In this mode, you can adjust the settings of each controller.

You may change the functions of several of the playing controls of the organ. Also, on the underside of the key bed is a jack for connecting the foot switch. You can select how a connected foot switch or CU-1 (half-moon Leslie switch) will function in this mode.

To locate this mode:

1. From either of the PLAY screens, touch the [MENU/EXIT] button. Menu A will display.
2. Touch the [4] CONTROL button.

▼KEY- BOARD SND. POINT DEEP ⑤	↕COUP- LER PtoG OF ⑬ 3C# ⑭ PtoS OF ⑮ 3C# ⑯	↕COUP- LER GtoP ⑰ 3C# ⑱	↕COUPLER ASSIGN PEDAL TO ⑲ GREAT ⑳
↕DRAW- BARS MODE ONLY[B] ⑲			
↕DISP SH. CUT TIMEOUT ⑲ 1 sec ⑳ NO			
↕DAMP- ER DRB ON ⑲ EXZ ON ⑳			
↕GLIDE RANG TIME AMP ⑲ -24 ⑳ 2.0 ㉑ ON			
↕EXPR ESSN SOURCE EXP. PED ⑲ 127 ㉑	↕EXP. MIN LEV ⑲ 35 ㉑ 25 ㉒ 30 ㉓	↕EXP. CALIB CURVE ⑲ 1 ㉑	MON 127
▲FOOT 1 (EXP. PED) MODE SW ⑲ LESLIE S/F ALT ㉑	▲FOOT 2 DEVICE SW ⑲ FOOT SW ㉑	▲FOOT 2 TIP MODE SW ⑲ DAMPER S ㉑	

◆ FOOT SWITCH

① FOOT SWITCH 1 - MODE (G)

This is for setting the function of the Foot Switch on the Expression Pedal.

OFF: No function.

LESLIE S/F ALT, MOM, TRI:

These are for switching SLOW/FAST of the Leslie effect.

At ALT, SLOW/FAST is alternately switched at each press of the Foot Switch, and at TRI, the Leslie rotors are switched OFF if the switch is held longer than 1 second.

At MOM, The Leslie rotors run FAST when the switch is pressed and held. Release the switch and the Leslie rotors run SLOW.

GLIDE:

Pressing the foot switch will cause the pitch to be lowered. The amount that the pitch is lowered is determined by a parameter setting (P. 67 #11 to 13).

DAMPER SWELL, GREAT, PEDAL:

Pressing and holding the foot switch while notes are pressed on SWELL, GREAT or PEDAL causes the notes to be sustained for as long as the foot switch is held. This function is similar to the damper pedal on a grand piano.

PRESET FWD, REV:

Pressing and releasing the foot switch will advance (FWD) or go backward (REV) through the SWELL Manual Presets.

SPRING:

Pressing and releasing the foot switch will produce a "spring shock" effect similar to the "gunshot" effect produced when a spring reverb unit is shaken or jostled.

DELAY TIME:

This function allows you to set the Delay Time of the Reverb effect (P. 66 #4) with the Foot Switch. For example, if you press and release the Foot Switch once, then press and release it again 0.2 seconds later, the delay time will be 0.2 seconds. You can then silence the Delay effect by pressing and holding the Foot Switch.

② FOOT SWITCH 2 - DEVICE (G)

This is for selecting which equipment is connected to the Foot Switch 2 jack.

PEDAL: for Foot Switch.

CU-1: for the Leslie Switch CU-1 (= optional).

③ FOOT SWITCH 2 - TIP MODE (G)

This is for setting the Foot Switch 2 jack.

▲FOOT 2 RING MODE SW
 ⑲ DAMPER S ㉑

tips DAMPER

The word "Damper" comes from the damper pedal of the piano.

It is also referred to as a "Sustain" pedal. Notes are held as long as the pedal is depressed.

tips SPRING REVERB

When an old-style Spring Reverb unit was shaken or bumped, the springs would strike the inside of their enclosure, resulting in a loud "bang." This sound has been used as an artistic effect in several styles of contemporary music. The SPRING setting replicates this effect.

tips TIP AND RING

TRS is an acronym for Tip-Ring-Sleeve, and refers to the fact that a connecting plug can have more than one connector. This means that more than one Foot Switch can be connected, thereby allowing you to control more than one function using the same Foot Switch jack.

If you wish to do this, you will need a Stereo Adapter which has a Stereo plug and two (2) Mono jacks. Insert the Stereo plug into the FOOT SW jack and connect a Foot Switch to each of the Mono input jacks. In most cases, the **Left** (L) input jack will access the Tip function while the **Right** (R) will access the Ring function.

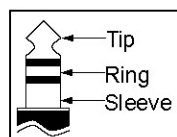

④ FOOT SWITCH 2 - RING MODE (G)

This is for setting the function on the RING contact, if you use the Foot Switch with a stereo adapter.

◆ EXPRESSION

⑤ EXPRESSION - SOURCE (G)

Determines what to use for controlling the Expression.

EXP. PED:

The Expression value is always controlled with the Expression Pedal. You may use this when you want to control the Expression Pedal with your foot, even while an external sequencer is playing.

MIDI: The Expression is controlled by receiving Controller #11 (Expression data) from the MIDI IN jack through the SWELL channel. You may use this when you want to control the Expression with an external sequencer.

⑥ EXPRESSION - MONITOR

Displays the present Expression value. You can find the causes for such trouble as “no sound”, or “non-function” of the Expression Pedal, by checking if the Expression value changes normally. Also, this can be a guide when you want to “fade in” from “quiet”.

⑦ EXPRESSION - MINIMUM LEVEL (G)

Sets the output level when the Expression is minimum.

The setting range is OFF, -40dB to 0dB. “OFF” makes no sound when the Expression is minimum, “0dB” does not reduce volume level.

⑧ EXPRESSION - LIMIT LF (G)

⑨ EXPRESSION - LIMIT HF (G)

These are for setting the level to maintain for low and high frequencies when the Expression is minimum.

The setting range is OFF, -40dB to -5dB. This function does not work at “OFF”. Otherwise the level is maintained even if the Expression is minimum.

⑩ EXPRESSION - CURVE (S)

This parameter sets how the value should vary corresponding to the depth of the expression pedal. The setting range is 1 to 3. Refer to the curves on the bottom right figure.

NOTE: This (S) is a System Parameter. This parameter will be remembered when set. It is common in each Preset.

◆ GLIDE

⑪ GLIDE - RANGE (P)

Sets the bend range of pitch by semitones. Setting range is -24 to +12.

⑫ GLIDE - TIME (P)

Sets the time from the start of glide to reach the pitch set at #11. The setting range is 0.1 to 5.0 seconds.

⑬ GLIDE - AMP (P)

Engages a “fade” along with the Glide, where the volume drops in tandem with the pitch to total silence.

◆ DAMPER

⑭ DAMPER - DRAWBAR (G)

⑮ DAMPER - EXTERNAL ZONE (G)

This is for determining whether to send the Damper information to each section. The combination of the foot switch and these Damper parameters decide on which part of which section the Damper effect is added.

For example, if you want to add the Damper effect on the External Zone of the SWELL manual with the foot switch on the Expression Pedal, set FOOT SWITCH 1 - MODE (#1) at “DAMPER SWELL”, and DAMPER - External Zone (#15) at “ON”.

tips EXPRESSION LIMIT

One of the human ear's characteristics is that when the volume falls, the sound of high or low frequencies becomes difficult to hear.

On this model, it is rectified. The perceived frequency range is maintained no matter what overall volume is chosen.

The similar function is adopted on most home audio equipment. It is called the “loudness” function.

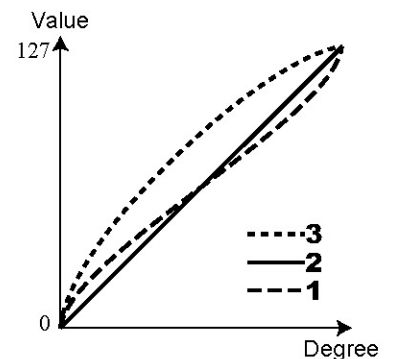
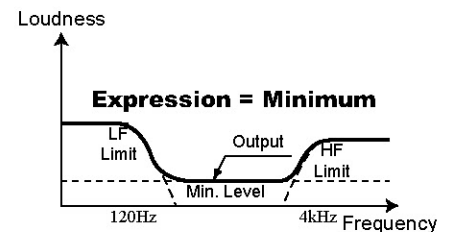
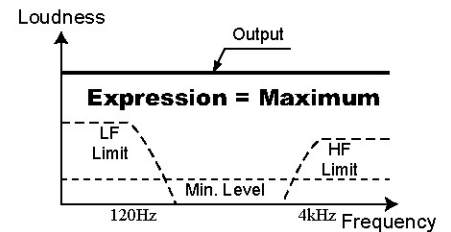

NOTE: The parameters with the letter (P) on the end are Preset Parameters, and are recorded to each Combination Preset. (G) is for “Global”. These parameters will be remembered when set, and are common in each Preset.

↖KEY- BOARD SND. POINT DEEP ⑫	↖COUP- LER PtoG OF 3C# PtoS OF 3C# ⑬	↖COUP- LER GtoP 3C# ⑭	↖COUPLER PEDAL TO ASSIGN GREAT ⑮
↖DRAW- BARS MODE ONLY[B] ⑯			
↖DISP SH. CUT TIMEOUT 1 sec NO ⑰			
(omitted)			

◆ DISPLAY

⑰ DISPLAY - SHORT CUT (G)

Sets the time limit to the short cut function.

The range 0 to 2 seconds and NO short cut. The short cut function does not work when the value is "NO".

⑱ DISPLAY - TIME OUT (G)

Sets the time limit to return to the previous screen from the one displayed by using the short cut operation.

The range is 4 to 16 seconds and NO time out. The time out function does not work when the value is "NO".

◆ DRAWBARS

⑱ DRAWBARS - CONTROL MODE (S)

This sets the condition for activating the registrations with the Manual Drawbars.

ONLY [B]:

The Drawbars are active only when the "B" Preset Key is selected, as on the original B-3/C-3/A-100.

ALWAYS:

The Drawbars are active regardless which Preset Keys are selected.

◆ COUPLER

⑲ COUPLER - PEDAL TO GREAT SWITCH (P)

This switches Pedal To Great ON and OFF.

NOTE: You can locate this page by holding down the [PEDAL TO GREAT] button as well.

⑳ COUPLER - PEDAL TO GREAT LIMIT (P)

This is used for determining the highest note on which the Pedal To Great will work.

㉑ COUPLER - PEDAL TO SWELL SWITCH (P)

This switches Pedal To Swell ON and OFF.

㉒ COUPLER - PEDAL TO SWELL LIMIT (P)

This is used for determining the highest note on which the Pedal To Swell will work.

㉓ COUPLER - GREAT TO PEDAL LIMIT (P)

This is used for determining the highest note on which the Great To Pedal will work.

NOTE: You can locate this page by holding down the [GREAT TO PEDAL] button as well.

㉔ COUPLER - ASSIGN (G)

Sets the [PEDAL TO GREAT] button to work as Pedal to Great or Pedal to Swell.

◆ KEYBOARD

㉕ SOUNDING POINT (S)

This sets the point along the key travel at which the notes will sound.

DEEP: Both the Drawbars and the Percussion sound at the deep point on the key travel.

AUTO: The Organ section sounds at the shallow point if the Percussion - Velocity (P. 73 #6) is "OFF" and Drawbar - Pedal Velocity (P. 63 #11) is "OFF."

tips ALTERNATE WAY TO SET THE LIMIT

The value of parameters named LIMIT are also set if you touch the desired note on each manual holding down the [JUMP/STORE] button, instead of using the [VALUE] button.

NOTE: The parameters with the letter (P) on the end are Preset Parameters, and are recorded to each Combination Preset. (G) is for "Global". (S) is "System". These parameters will be remembered when set, and are common in each Preset.

This mode allows you to adjust the overall tuning of the A-162.

To locate this mode:

1. From either of the PLAY screens, touch the [MENU/EXIT] button. Menu A will display.
2. Touch the [PAGE ▲] button three times. Menu D will display.
3. Touch the [3] TUNE button.



1 MASTER TUNE

This will change the tuning or “pitch” of the entire organ.

The setting range is A = 430 - 450 Hz.

NOTE: The Parameter in this mode is a Global Parameter. It is recorded when the value is set, and is common at each Combination Preset.

CUST. TW (CUSTom Tone Wheels)

In this mode, you can regulate each virtual tone wheel set of the Manual Drawbars, wheel by wheel.

Each virtual tone wheel set consists of 96 different pitches representing 96 tone wheels. Although the vintage B-3/C-3/A-100 had only 91 sounding tone wheels, later models such as the "H" series had 96. Thus the CUST.TW feature can be used to replicate any console Hammond Organ which used tone wheels to produce the sounds.

Each individual pitch is produced by one tone wheel, so that the same pitch can be made to sound from different playing keys by using different Drawbars. For example, the "middle C" pitch is played by "4C" (the fourth "C" on the manual) when the first

brown Drawbar is used, but by the third "C" ("3C") when the first white Drawbar is used.

In this organ, you can save 5 types of settings for each tone wheel set. We call this "CUSTOM TONE WHEELS".

As a sample for customization, the typical settings are programmed at the factory.

To locate this mode:

1. From either of the PLAY screens, touch the [MENU/EXIT] button. MENU A will display.
2. Touch the [PAGE ▲] button once, Menu B will display.
3. Touch the [1] CUST. TW button.

④	WHEEL LEV LPF RES	WHEEL HPF
	01:1C# ⑤ + 0 ⑥ 127 ⑦ 0 ▶	01:1C# ⑧ 0
	CUSTOM NAME	
	Real_B-3	
	CUSTOM NUMBER	
	BType1 ② 1:Real B-3	
	TONEWHEEL	
	BType1 ①	

① TONE WHEEL SET

This is for selecting the tone wheel set.

② CUSTOM NUMBER

This is for selecting the "CUSTOM NUMBER" to use or compile. The "*" will be displayed when the Custom Tone Wheel parameters are changed from the selected setting.

NOTE: This parameter is a Preset Parameter. It is recorded into the Preset.

③ CUSTOM NAME

You can name the Custom Tone Wheel set using up to 10 letters.

Move the cursor by the [PARAM] button and choose the characters by the [VALUE] button.

The available characters include upper- and lower-case letters (A - Z, a - z), numbers (0 - 9) and punctuation marks and symbols.

By touching the [VALUE] button while holding down the [JUMP] button, you can jump to the first of each letter type (space, symbol, 0, A, a).

In order for the name to be remembered as well as the other changes to the Custom Tone Wheel parameters, you must save them as a new Custom Tone Wheel setting. This is explained starting below.

④ WHEEL NUMBER

Select the number of the tone wheel you want to regulate.

To select the wheel number, select the [VALUE] button here, or slightly move the Drawbar while depressing the key you want to regulate (see the illustration on the right).

When the wheel number is selected, each parameter for the wheel (#5, #6, #7, #8) is displayed.

tips

INITIAL VALUE OF THE CUSTOM NUMBER

The typical settings are saved to the Number 1 - 3 (or 4), as the initial value.

For example, to the BType1, "Real B-3" simulating the well-preserved B-3/C-3/A-100 and "80's Clean" with less noise, rough sound "Noisy", and "Noisy 60" with louder leakage noise is stored.

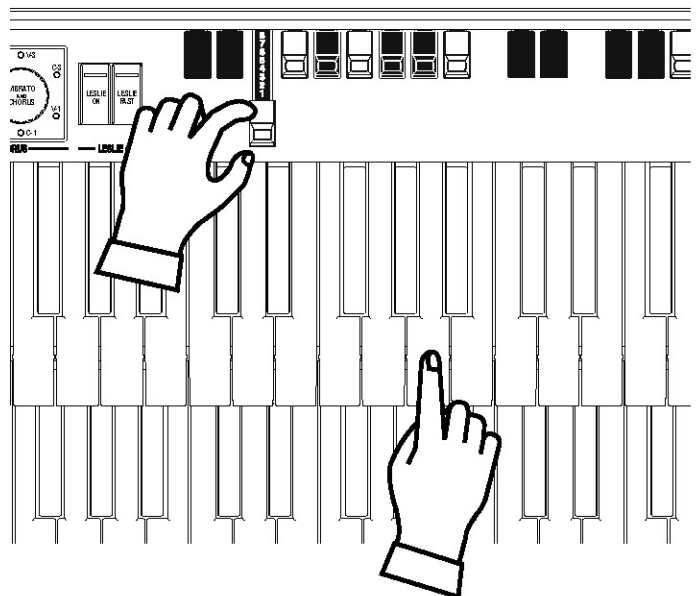

How to select the WHEEL NUMBER

5 LEVEL

This is for setting the volume of a virtual tone wheel.

The setting range is -20 to +2 dB. If you increase the value, the volume increases.

6 CUT OFF FREQUENCY - LPF

This is for setting the Frequency to cut the Treble of a virtual tone wheel.

If you increase the value, a leakage noise is heard besides the original tone wheel pitch.

If you decrease the value, the sound becomes more mellow as the treble is cut off.

The setting range is 0 - 127.

NOTE: If the value is decreased too low below the fundamental tone wheel pitch, the wheel volume will be reduced.

7 RESONANCE - LPF

This is setting the level around the Cut Off Frequency - LPF (#6).

The setting range is -100 to +100. The higher value boosts treble, and lower values cut treble smoothly.

8 CUT OFF FREQUENCY - HPF

This is for setting the Frequency to cut the Bass of the selected tone wheel.

If you decrease the value, a motor hum (= noise) is heard besides the original virtual tone wheel sound.

The setting range is 0 - 127.

NOTE: If you increase the value too high above the original tone wheel pitch, the sound will get "thin".

NOTE: The parameters 3 - 8 are the virtual tone wheel Parameters. If you do the recording operation described on the next page, it works in common with the same virtual tone wheel set of each Combination Preset.

NOTE: When you operate the parameters 3 - 8, if you do not save them using the recording procedure described on the next page, they will be lost when the power is switched "OFF."

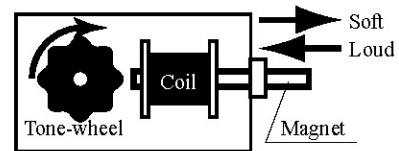

Concept of the LEVEL ADJUSTMENT

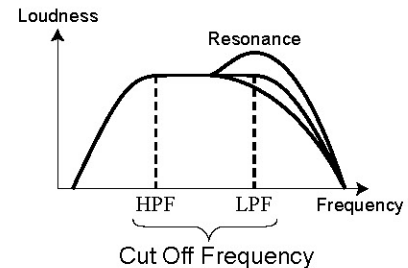
**tips LEAKAGE NOISE**

In the vintage electro-mechanical Hammonds, sometimes the signal from adjacent tone wheels would be picked up (or "leaked") along with the current tone wheel being played. This "hash" noise, another Hammond anomaly originally considered to be a defect, grew to be an integral part of the Hammond sound.

"Mellow", "Brite", and "Saw" settings do not include the Leakage Noise.

tips DISTORTION

If you raise the Level and Resonance values too much, it changes the gain in the sound engine and may sometimes cause distortion, i. e. unpleasant noise.

Store the CUSTOM virtual tone wheels

The tone wheel Parameters (= 3 - 8 of the previous paragraph) can be stored as a Custom Tone Wheel. In this way you can recall your parameter settings during performance.

1



Enter the Custom Name if desired. (P. 70 #3)

2

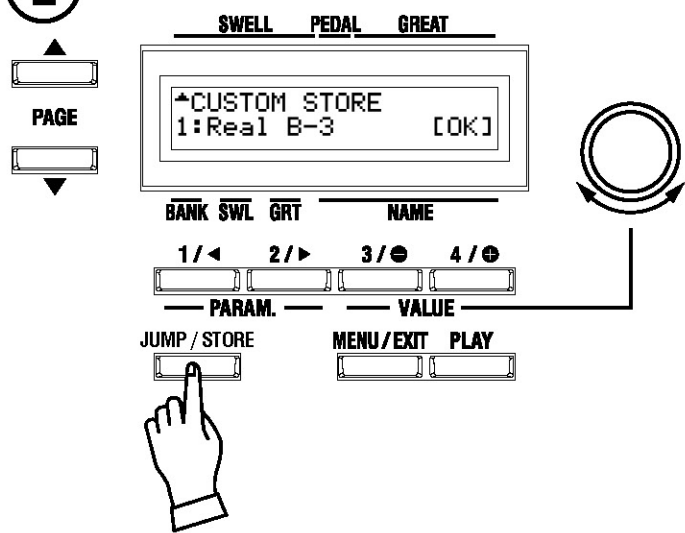

Touch the [JUMP/STORE] button in the setting mode of the tone wheel Parameters.

The mode for selecting the Custom Number to be recorded will be displayed.

3

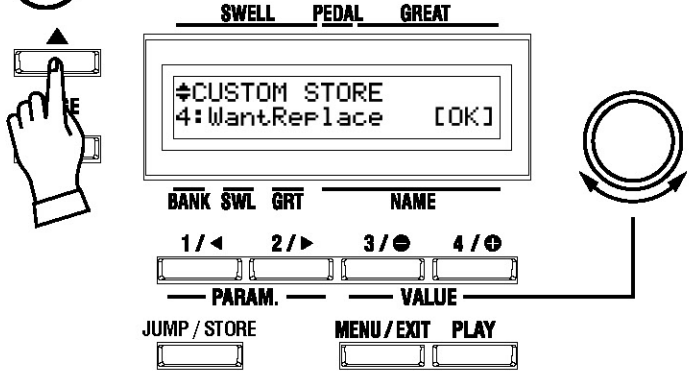

Select the Custom Number to be recorded by the [PAGE] button.

4

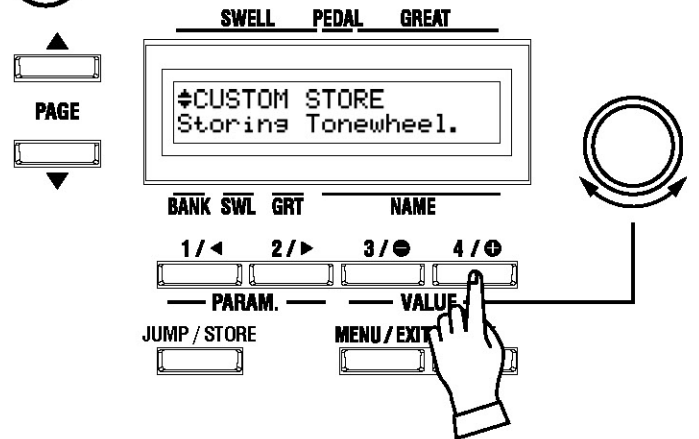

Touch the [4] OK button to save your settings. The display will show as above for approximately 1 second.

NOTE: If you do not wish to save your settings, touch the [MENU/EXIT] button.

In this mode, you can set the parameters of the Percussion sound.

To locate this mode:

1. From either of the PLAY screens, touch the [MENU/EXIT] button. Menu A will display.
2. Touch the [PAGE ▲] button once. Menu B will display.
3. Touch the [2] PERCUSS button.
 1. Or, hold down either [SECOND], [THIRD], [FAST], or [SOFT] button for a few moments.

▼PERC	1' CANCEL	LEVEL
DRAWB	③ ON	⑨ -3dB
⬆PERC	TOUCH	VEL KTRK
KBD	⑤ ON	⑥ OF ⑦ ON
⬆PERC	SLOW	FAST
DECAY	③ 8	④ 3
▲PERC	SOFT	NORM
LEVEL	① 6	② 12

① LEVEL - SOFT

② LEVEL - NORMAL

These are for setting the volume of Percussion. SOFT is the volume when the [SOFT] button is "ON," and NORMAL is the volume when the [SOFT] button is "OFF."

The setting range is 1 to 16. The higher the value, the louder the volume.

③ DECAY - SLOW

④ DECAY - FAST

Normally the Percussion decay is SLOW when the [FAST] button is "OFF" (LED not lit) and FAST when the [FAST] button is "ON" (LED lit). However, with this feature you can adjust the rate at which the Percussion will decay for either SLOW or FAST button settings.

The setting range is 1 to 9 and "C." The higher the value, the longer the Decay Time. When "C" is selected, the Percussion will not decay but sound continuously.

⑤ KEYBOARD - TOUCH

This is for setting the method of triggering the Percussion.

ON: This replicates the Touch-Response Percussion function on the original models B-3/C-3/A-100. The Percussion tones will sound only if you play the keys in a detached manner (non-legato). Any degree of detachment is sufficient.

OFF: This replicates the "legato non-retriggering" Percussion function on the X-66, Concorde and later model Hammond Organs. Each key will sound when played regardless of whether other keys are being held.

⑥ KEYBOARD - VELOCITY

This is for selecting whether the Percussion tones respond to key velocity.

ON: Percussion volume increases with increased keyboard velocity.

OFF: Percussion volume remains constant, regardless of velocity.

⑦ KEYBOARD - KEY TRACK

Changes the Percussion Volume by the position on the keyboard.

ON: The Percussion tones will be gradually reduced in volume on the higher notes.

OFF: The volume of the Percussion will stay at the same level throughout the entire compass of the manual.

⑧ DRAWBAR - 1' CANCEL

This mutes the 1' SWELL Drawbar while using Percussion.

ON: Mute.

OFF: Does not mute.

⑨ DRAWBAR - LEVEL

Decrease the volume of SWELL Drawbars while using Percussion.

0dB: Does not decrease the volume.

-3dB: Decreases the volume by the same amount as the B-3/C-3/A-100 spec.

-5dB: Decreases the volume by 5dB in the middle octave and by varying amounts in other octaves, similar to an older vintage organ.

NOTE: This parameter works only when the [SOFT] button is "OFF."

NOTE: The parameters in these modes are all Preset Parameters.

tips 1' CANCEL

The B-3/C-3/A-100 had no key contact exclusively for Percussion but used the 1' contact for Percussion. This feature is replicated on this organ.

tips DRAWBAR LEVEL

On the B-3/C-3/A-100, the Drawbar Volume was slightly reduced when the Percussion was engaged. This characteristic is replicated on this organ.

tips KEY TRACKING

On the original Hammond Organs with Touch-Response Percussion Control, such as the B-3/C-3/A-100, the Percussion sounds would taper off slightly at higher frequencies. This feature is replicated on this organ.

In this mode, you can adjust the settings for the built-in Digital Leslie and the External Leslie Speaker.

The Digital Leslie has many parameters to adjust. As you set these parameters to your liking, you will be creating a "Custom Leslie Cabinet." When you create a Custom Leslie Cabinet, you can also give it a unique name. You select the CABINET NUMBER in each SWELL Preset Key.

EXT. LESLIE CH 20 3		
MIC ANGLE DISTANCE 18 150° 19 0.6m		
BASS SLOW FAST LEV SPD 12 36 13 393 14 0 ▶	BASS RISE FALL BRAK TIME 15 7 16 5 17 10	
HORN SLOW FAST LEV SPD 5 36 6 393 7 0 ▶	HORN RISE FALL BRAK TIME 8 2.2 9 1 10 1.2 ▶	HORN CHARACTER TYPE 11 MID
AMP/ AMP SPEAKER SPKR 3 Solid 4 RotLarge		
CAB. NAME 2 147-Type		
CAB. NUMBER 1 1:147-Type		

To locate this mode:

1. From either of the PLAY screens, touch the [MENU/EXIT] button. Menu A will display.
2. Touch the [PAGE ▲] once. Menu B will display.
3. Touch the [4] LESLIE button.
1. Or, hold down either LESLIE [BRAKE], [ON] or [FAST] button.

◆ CABINET NUMBERS

① CABINET NUMBER (P)

This is for selecting the Cabinet number to use in the Presets.

The setting range is 1 - 8. The "*" will be displayed when the Leslie parameters are changed from the selected Cabinet number.

◆ LESLIE PARAMETERS

② CABINET NAME (L)

This is for assigning the Cabinet names.

Move the cursor by the [PARAM] button and select letters by the [VALUE] button. The available characters include upper- and lower-case letters (A - Z, a - z), numbers (0 - 9) and punctuation marks and symbols.

If you touch the [VALUE] button while touching and holding down the [JUMP/STORE] button, you can move to the first letter of each type (= space, symbol, 0, A, a).

In order for the name to be remembered as well as the other changes to the Leslie parameters, you must save them as a Leslie Cabinet. This is explained starting below.

③ AMPLIFIER (L)

This sets the type of the virtual power amplifier.

Solid: Transistorized (or "solid-state") amplifier.

Tube: Simulated Tube Amplifier.

④ SPEAKER (L)

This sets the type of the virtual speaker.

RotSmall: A small (33" tall) cabinet such the model 142.

RotLarge: A standard-size (41" tall) cabinet such as the model 122.

Station: A stationary speaker such as the Hammond PR-40.

tips CONCEPT OF THE CABINET NUMBERS

Each Cabinet represents one virtual Leslie Speaker prepared by the Leslie Parameter.

This is a unique Preset Parameter in this mode.

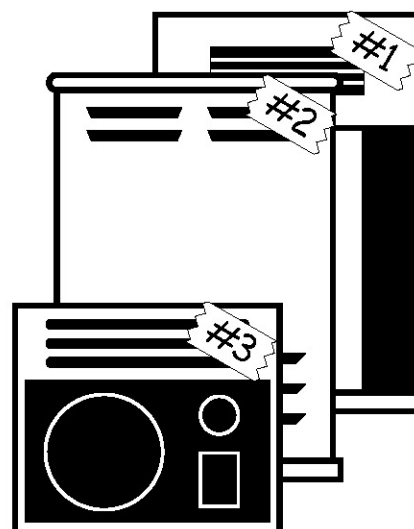

5 SLOW SPEED - HORN (L)

This sets the speed of the Rotor in Slow mode.

The setting range is 0, 24 - 318 rpm. It does not rotate at 0.

12 SLOW SPEED - BASS (L)**6 FAST SPEED - HORN (L)**

This sets the speed of the Rotor in Fast mode.

The setting range is 0, 24 - 453 rpm. It does not rotate at 0.

13 FAST SPEED - BASS (L)**7 HORN LEVEL (L)****14 BASS LEVEL (L)**

The Volume of each Rotor is set. The setting range is 0 to -12 dB.

8 RISE TIME - HORN (L)**15 RISE TIME - BASS (L)**

This sets the time for the Rotor to reach the Fast Speed, when you go from Slow or Brake to Fast mode. The setting range for the Horn Rotor is 0.2 - 5.0 seconds and 0.5 - 12.5 seconds for the Bass Rotor.

9 FALL TIME - HORN (L)**16 FALL TIME - BASS (L)**

This sets the time for the Rotor to reach the Slow Speed, when you go from Fast to Slow mode. The setting range for the Horn Rotor is 0.2 - 5.0 seconds and 0.5 - 12.5 seconds for the Bass Rotor.

10 BRAKE TIME - HORN (L)**17 BRAKE TIME - BASS (L)**

This sets the time for the Rotor to stop, when you go from Fast mode to Brake. The setting range for the Horn Rotor is 0.2 - 5.0 seconds and 0.5 - 12.5 seconds for the Bass Rotor.

11 HORN CHARACTER (L)

This sets the tone of the Horn Rotor.

“FLAT” has no cut or boost. The others exhibit various harmonic “peaks”.

18 MIC - ANGLE (L)

This sets the locations of the two virtual microphones for the virtual Leslie Speaker.

The ANGLE selects the distance between the two mikes.

The setting range is 0 - 180°. As you increase the range, the stereophonic image is enhanced.

19 MIC - DISTANCE (L)

This sets the Distance between the virtual Leslie Speaker and the Microphones.

The setting range is 0.3 - 2.7 meters. As the “distance” grows, the Leslie effect is less pronounced.

NOTE: These parameters 2 - 19 (L) can be saved as part of a Custom Leslie Cabinet. If you do not save your changes, they will be lost when the power to the instrument is switched “OFF.”

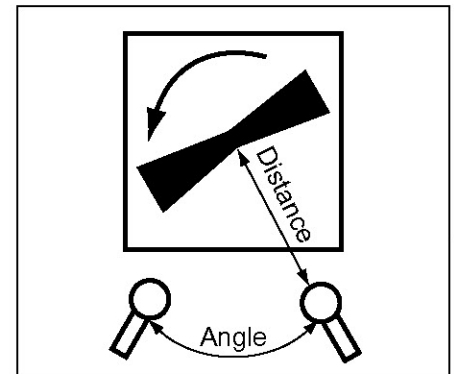
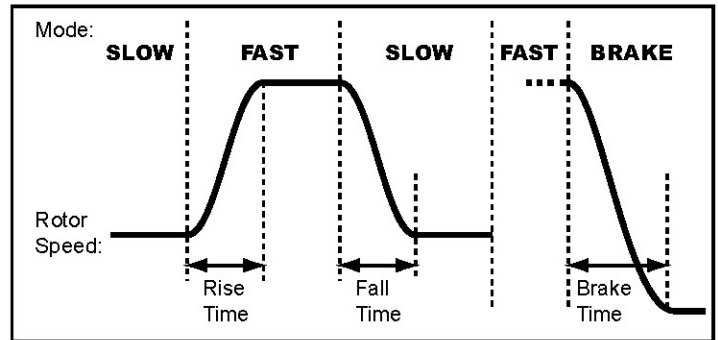

↵EXT. LESLIE CH ⑳ 3								
↵MIC ANGLE DISTANCE ⑮ 150° ⑩ 0.6m								
↵BASS SLOW FAST LEV SPD ⑫ 36 ⑬ 393 ⑭ 0 ▶			↵BASS RISE FALL BRAK TIME ⑮ 7 ⑯ 5 ⑰ 10					
↵HORN SLOW FAST LEV SPD ⑤ 36 ⑥ 393 ⑦ 0 ▶			↵HORN RISE FALL BRAK TIME ⑧ 2.2 ⑨ 1 ⑩ 1.2 ▶			↵HORN CHARACTER TYPE ⑪ MID		
↵AMP/ AMP SPEAKER SPKR ③ Solid ④ RotLars ⑤								
↵CAB. NAME ② 147-Type								
↵CAB. NUMBER ① 1:147-Type								

◆ EXTERNAL LESLIE SPEAKER

④ LESLIE CHANNEL (S)

The Channel is set for the Leslie Speaker connected to the 11-pin terminal.

- 1ch:** Use this setting when connecting to a 122XB, 971/981/3300(not expanded), 147, 771, or other single-channel Leslie cabinet. The Drawbar and Percussion sounds will be heard through the single Rotary channel.
- 3ch:** Use this setting when connecting to a 2101, 971/981/3300(expanded with stationary speakers), 814, a 914, or other 3-channel Leslie cabinet. The sounds will play through the Stationary channel when both the [LESLIE ON] and [LESLIE BRAKE] buttons are "OFF." Otherwise, the sound comes out of the Rotary channel.

If you connect this organ and Leslie 3301/525 with the exclusive Y cable, the Drawbar sound and the built-in Leslie effect are both output to the Stationary channel.

NOTE: This is a System Parameter, meaning that it is common for each Preset and its selected value is automatically stored.

Store the Cabinets

The Leslie parameters (#2 - 19 of the previous paragraph) can be stored with the Cabinet numbers, and you can choose and use them in each Preset.

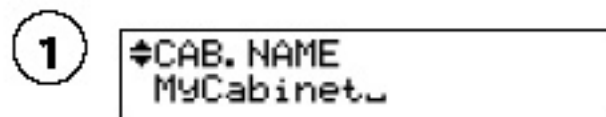

Enter the name for the Cabinet. (P. 74 #2)

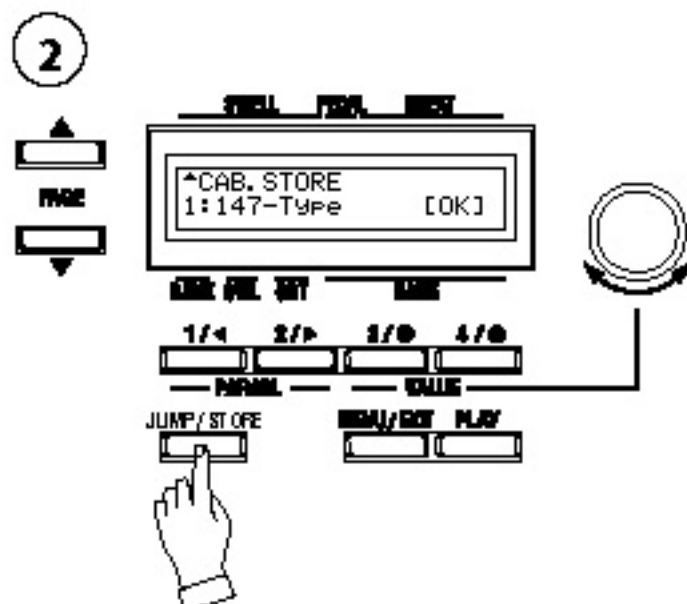

Touch the [JUMP/STORE] button in the setting mode (#2 - 19) of the Leslie Parameter.

The Cabinet Selection mode is displayed.

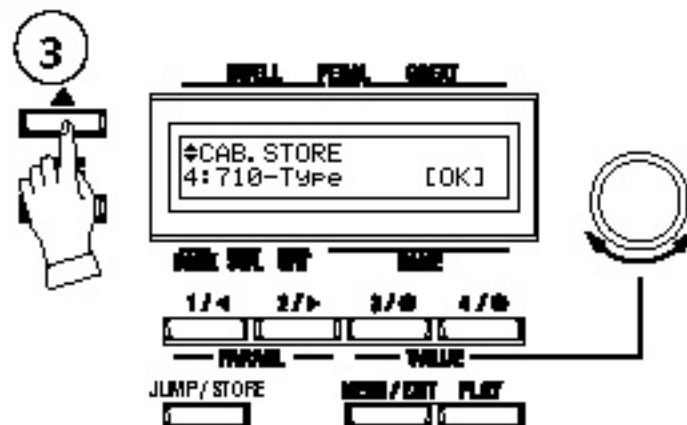

Select the Cabinet Number to record by the [PAGE] button.

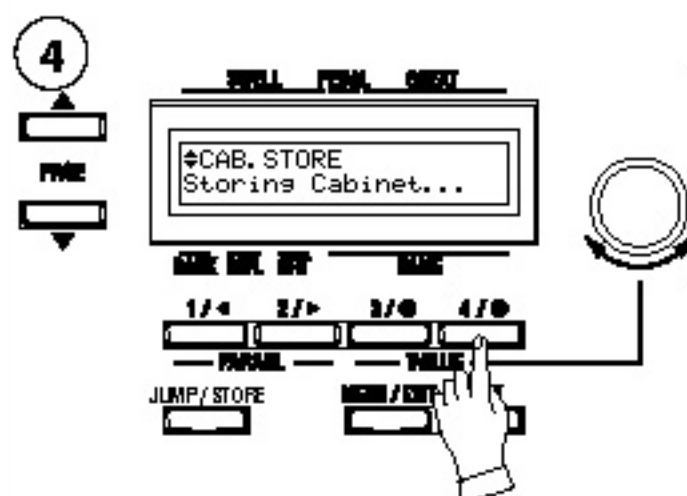

Touch [4] OK, and it is recorded.

The display will show as above for approximately 1 second.

NOTE: If you do not wish to save your changes, touch the [MENU/EXIT] button.

OD/VIB (OverDrive / VIBrato)

In this mode, you can change the settings for Overdrive, Vibrato and Chorus.

To locate this mode:

1. From either of the PLAY screens, touch the [MENU/EXIT] button. Menu A will display.
2. Touch the [PAGE ▲] button once. Menu B will display.
3. Touch the [3] OD/VIB button.
 1. Or, Touch and Hold the Vibrato & Chorus [ON SWELL] or [ON GREAT] button for a few moments.

▼VIB V1 V2 V3 DEPTH ⑨13 ⑩10 ⑪14 ▶	▼VIB C1 C2 C3 DEPTH ⑫8 ⑬11 ⑭14
↕VIB RATE TREM V&C ④6.83Hz ⑤10 ▶	↕VIB EMPH MIX PEDL V&C. ⑥9 ⑦16V ⑧ON
▲OD SW DRIVE EXP. ①OFF ②0 ③EX-OD	

◆ OVERDRIVE

① OVERDRIVE - SWITCH

Turns the Overdrive effect “ON” or “OFF”

② OVERDRIVE - DRIVE

This is for adjusting the Overdrive Value.

The setting range is 0 to 127. The higher the value, the more distortion.

③ OVERDRIVE - EXPRESSION

This is for varying the amount of Overdrive by changing the Expression value.

EX-OD:

If you operate the Expression pedal, not only the volume but also the distortion will be changed.

OD-EX:

The Expression Pedal affects only the volume and not the distortion amount.

OD ONLY:

The Expression pedal affects only the distortion amount and not the volume.

◆ VIBRATO & CHORUS

④ VIBRATO - RATE

This is for setting the Rate or Speed of the Vibrato and Chorus effect.

The setting range is 6.10 - 7.25 Hz.

⑤ VIBRATO - TREMOLO

This is for setting the Tremolo (amplitude modulation) of the Vibrato and Chorus effect.

The setting range is 0 - 15.

⑥ VIBRATO - EMPHASIS

This is for setting the Emphasis (high frequency boost) of the Chorus effect (C1 / C2 / C3).

The setting range is 0 - 9 dB.

⑦ MIX

This is for setting the balance between the vibrato and non-vibrato tones for the Vibrato Chorus effect. (C1 / C2 / C3).

The setting range is D64 (only the Direct tone, no vibrato tone) - EVEN (an equal mix of vibrato and non-vibrato tone) - 63V (only the Vibrato tone, no direct tone).

⑧ PEDAL

Select Vibrato effect “ON” or “OFF” for the PEDAL tones using the [VIBRATO ON GREAT] button.

⑨ VIBRATO - DEPTH V1

⑩ VIBRATO - DEPTH V2

⑪ VIBRATO - DEPTH V3

⑫ VIBRATO - DEPTH C1

⑬ VIBRATO - DEPTH C2

⑭ VIBRATO - DEPTH C3

These are for setting the Depth of each Vibrato and Chorus effect mode.

The setting range is 0 - 15.

NOTE: The parameters in these modes are Preset Parameters and are recorded to each Preset.

Vibrato and Chorus of Hammond Organs

On string instruments, the vibrato effect is created by changing the vibrating length of the string by one's fingers. On wind instruments, by changing the strength of breath. On electronic instruments with analog circuitry, by modulating the oscillator. As the rotation of the tone wheels of the original B-3/C-3/A-100 was stabilized by the synchronous motor, it was not possible to provide a vibrato effect. On these models, the vibrato effect was obtained by modulating the signal post-generator.

The vibrato & chorus system of the original B-3/C-3/A-100 consisted of a 9 stage delay line using LC phase shift circuits. This produced a very short delay of about 1 ms. Tones were passed through coils, delaying the phase. Several coils were connected in tandem and when the output of each tap was passed from the top to the last by turns, the pitches gradually lowered. By taking the output of each tap from the last to the top by rotations, the pitch would gradually rise. These operations were made by means of a rotating device called a "scanner" which intercepted the output of each tap. The scanner would scan the entire length of the delay line for V3/C3, approximately half of it for V2/C2 and about a third of its length for V1/C1.

The scanner was used to select one of multiple input terminals by the static connection. As each terminal was selected by the "blades" which approached each other, and the signals of neighboring terminals cross-faded and switched themselves.

As this system modulated the produced tonal signals and not the oscillator, the original sound could be heard without the vibrato effect. By mixing the sound with the vibrato effect and the original sound, the chorus effect was obtained.

On this model, the chorus and vibrato effects are replicated in the original fashion digitally by our proprietary DSP, without using moving parts.

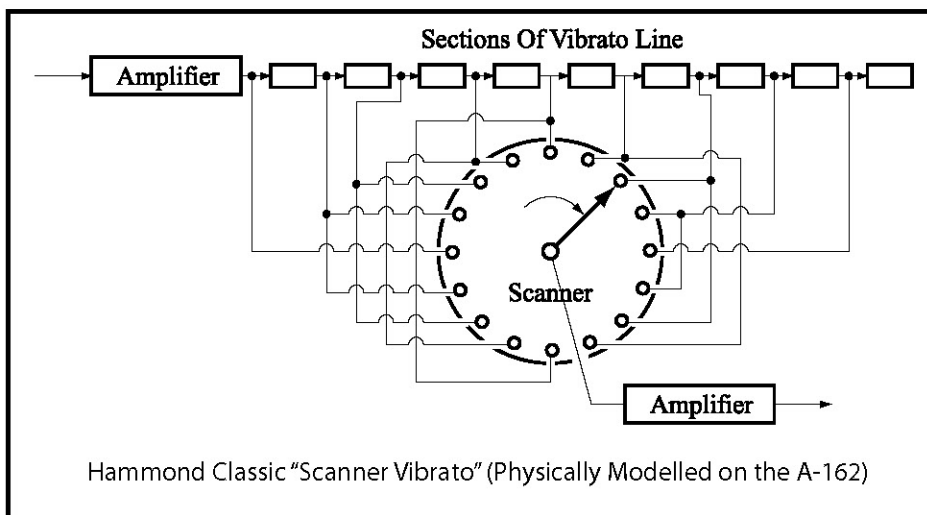

EQUALIZ (EQUALIZer)

In this mode, you can adjust the settings for the Equalizer.

An Equalizer is used to adjust the tonal quality. The built-in Equalizer consists of 3 bands and Tone Control. With the 3 bands ranging bass to treble, you can boost or cut any of them.

To locate this mode:

1. From either of the PLAY screen, touch the [MENU/EXIT] button. Menu A will display.
2. Touch the [PAGE ▲] button twice. Menu C will display.
3. Touch the [2] EQUALIZ button.

▼TONE	ASSIGN
KNOB	⑥ TREB
▲EQ	TC BS G-MID-F TR
DRB	① 0 ② 0 ③ 0 ④ 1.0k ⑤ 0

① TONE CONTROL

This models the “screw-set” tone control that was present on the preamp inside of the B-3/C-3/A-100. It gently cuts the treble.

The setting range is -9 to +9, and it becomes neutral when set at “0”.

NOTE: On the A-162, this can also be used to boost the treble as well as cut it.

“-1” corresponds to the maximum of the B-3/C-3/A-100 tone control, “-5”, the middle, “-9” the minimum.

② GAIN - BASS

③ GAIN - MIDDLE

⑤ GAIN - TREBLE

These are for doing the Boost / Cut of Bass, Middle and Treble respectively. The setting range is -9 to +9. “0” is a neutral setting.

④ FREQUENCY - MIDDLE

This is for setting the Central Frequency to vary at Gain - Middle (#3).

The setting range is 480 Hz - 2.9 kHz.

⑥ TONE - ASSIGN

This sets the function to assign the parameter of each gain: either Bass, Middle or Treble, and tone control to the [TONE] knob. You can change this while playing.

NOTE: This parameter (6) is a Global Parameter. It is recorded when the value is set. Also, it is common at each Preset.

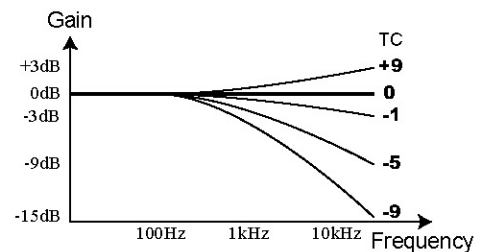

tips THE EFFECTIVE USE OF THE TONE

If the organ is in a large room, greater clarity of sound can be achieved by using the [TONE] control to boost the TREBLE. Otherwise the sound may be indistinct or “muddy.”

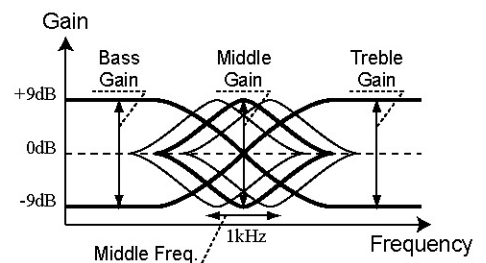

tips THE EFFECTIVE USE OF THE MIDDLE FREQUENCY

The frequency response of the horn rotor in the Leslie speaker is not flat. It has a peak from 1 kHz to 3 kHz that is another component of the classic Hammond Sound.

When you play this organ without a Leslie speaker, you can get a similar effect by setting the FREQUENCY - MIDDLE to about 2 kHz, and the GAIN - MIDDLE to “+”.

tips PRESET PARAMETERS

Equalizer is a Preset Parameter, designed to actively use as one of the tone-making parameters. However, you may not want the Equalization to change when you are switching Presets. In this case, if you set the P. LOAD RV/EQ switch in the PRESET function mode to “OFF,” the Equalizer value does not change when the preset is recalled. (P. 64)

In this mode, you can adjust the setting for the Reverb effect.

To locate this mode:

1. From either of the PLAY screens, touch [MENU/EXIT] button. Menu A will display.
2. Touch the [PAGE ▲] button twice. Menu C will display.
3. Touch [1] REVERB button.
1. Or, Touch and Hold the [REVERB] button.

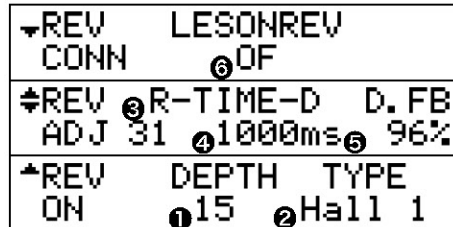

① DEPTH

This sets the Depth (= volume) of the Reverb effect.

② TYPE

This sets the Types of Reverb effect.

- Room 1:** Inside the room (short)
- Room 2:** Inside the room (long)
- Live:** Club
- Hall 1:** Concert Hall (long)
- Hall 2:** Concert Hall (short)
- Church:** Church or large auditorium with a high ceiling
- Plate:** Iron-plate Reverb
- Spring:** Spring Reverb
- Delay:** Echo effect
- PanDly:** Panning Delay
- RevDly:** Reverb + Delay

③ REVERB TIME

This sets the length of the Reverb effect.

NOTE: "Spring," "Delay," "PanDly," and "RevDly" are not affected by this parameter.

The setting range is 0 - 31. The higher the value, the longer the reverb time. A longer reverb time will create the effect of a larger room or hall.

④ DELAY TIME

This sets the Delay Time (the length of time between the original sound and each repeat).

NOTE: This parameter affects the "Delay," "PanDly," and "RevDly, settings.

The setting range is 4.7 - 2000 ms. The higher the number, the longer the delay.

NOTE: You can set the delay time with the foot switch (P. 66)

⑤ DELAY FEEDBACK

This sets the Delay Feedback (the number of times the sound will repeat).

NOTE: This parameter affects the "Delay," "PanDly," and "RevDly, settings.

The setting range is 0 - 96%. The higher the value, the greater the number of repetitions.

⑥ LESLIE ON REVERB

This allows you to select whether the Reverb will be affected by the Leslie effect.

- OFF:** Reverb does not contain the Leslie effect.
- ON:** Reverb also contains Leslie animation.

NOTE: REVERB - TYPE allows global setting of reverb parameters. When you select the Reverb Type(#2), each reverb parameter (#3 to #5) will be set to the most suitable value.

NOTE: All the parameters in these modes are Preset Parameters. They are recorded into the SWELL Preset Keys.

DEFAULT

In this mode, you can restore the organ to its factory default settings. You can choose to reset the entire system or only selected portions of it.

To locate this mode:

1. From either of the PLAY screens, touch the [MENU/EXIT] button. Menu A will display.
2. Touch the [PAGE ▲] button three times. Menu D will display.
3. Touch the [4] DEFAULT button.

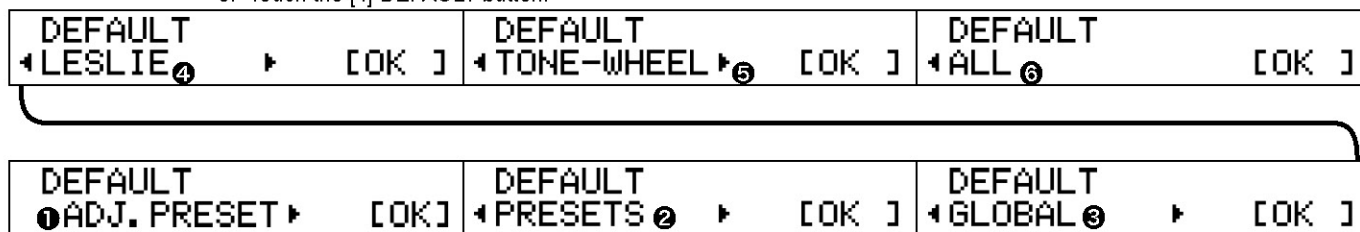

To initialize each parameter, touch the [PARAM] button and then [4] OK.

① ADJUST PRESET

Initializes the content of the “B” Preset Keys.

This is helpful for creating new Presets.

② PRESETS

Initializes the content of all Presets.

③ GLOBAL

Initializes the Global Parameters such as Master Tune or assignment of the Foot Switch.

④ LESLIE

Initializes the content of all Custom Leslie Cabinets.

⑤ TONE WHEEL

Initializes the content of all Custom Tone Wheels.

⑥ ALL

Initializes all parameters of this organ.

NOTE: You can also initialize the entire system by touching and holding the [RECORD] button and switching the power “ON.”

In this mode, you can set the System Parameters of this organ and the display information.

To locate this mode:

1. From either of the PLAY screens, touch the [MENU/EXIT] button. Menu A will display.
2. Touch the [PAGE ▲] button four times. Menu E will display.
3. Touch the [1] SYSTEM button.

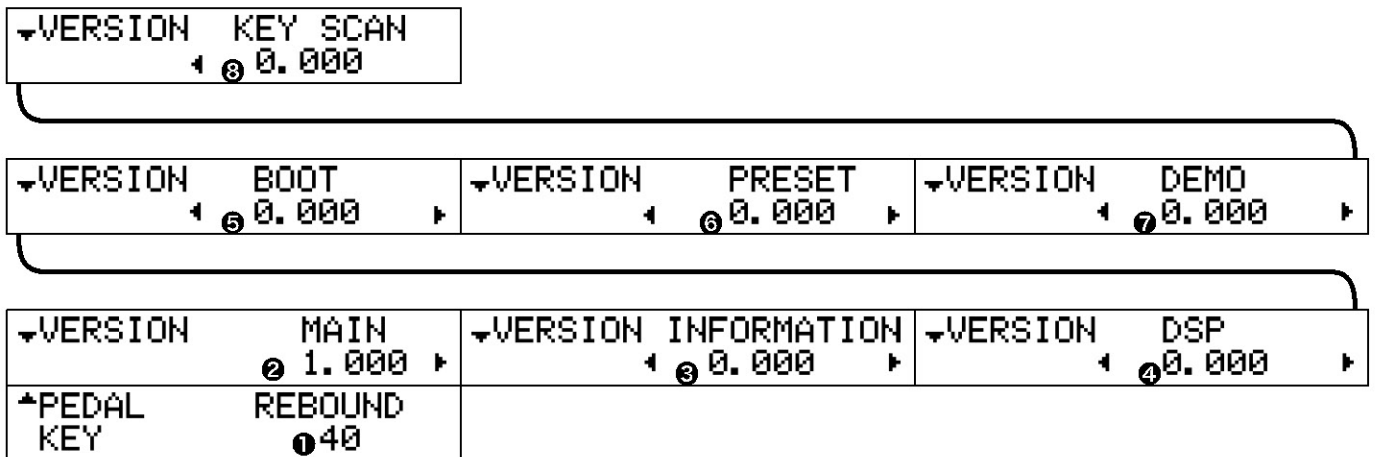

1 PEDAL KEY - REBOUND

The notes played by the pedals sometimes sound twice caused by the “rebound” which happens when the pedals are played staccato and released, depending on the tension of the sheet spring used on it. This can be avoided by adjusting the “rebound time”

The setting range is 1 - 128 × 1.4 milliseconds. The initial value is 40 × 1.4 milliseconds.

NOTE: If the rebound time is too long, it causes a sound delay.

NOTE: This is meant to be only a temporary fix. To eliminate the problem permanently, the tension of the sheet spring or springs should be adjusted to the proper amount.

2 VERSION - MAIN

3 VERSION - INFORMATION

4 VERSION - D. S. P.

5 VERSION - BOOTSTRAP PROGRAM

6 VERSION - FACTORY PRESETS

7 VERSION - DEMONSTRATION

8 VERSION - KEY SCANNER

These are the versions of the various software modules of the organ.

These numbers cannot be changed, and are for information purposes only.

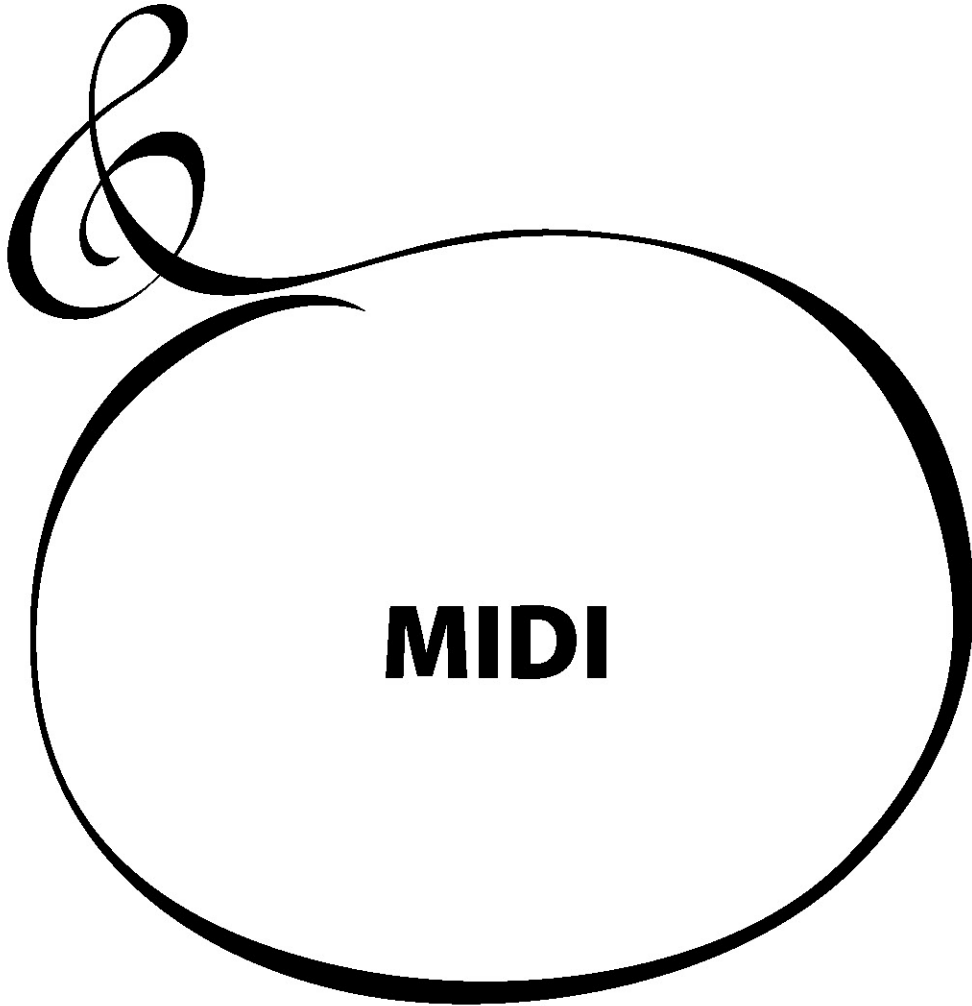

What is “MIDI” ?

MIDI is an abbreviation of **M**usical **I**nstrument **D**igital **I**nterface.

MIDI is the musical instrument industry standard for exchanging performance information between electronic musical instruments and a sequencer, effects, lighting and sound reinforcement gear, etc.

The MIDI standard allows instruments made by different manufacturers to effectively communicate with each other.

Many types of data can be transmitted and received, including all performance information, settings of parameters, and global commands.

MIDI terminals on this Organ

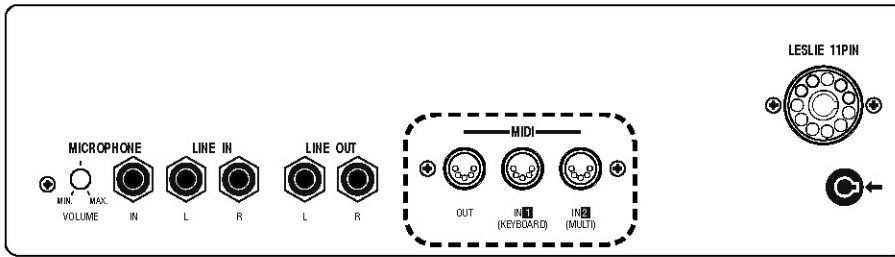

MIDI OUT Jack

Sends Performance Information.

This is used for playing an external MIDI sound module from this organ, or for recording the performance on this organ to an external sequencer.

MIDI IN Jack

This jack is for playing the keyboard channels (SWELL, GREAT, PEDAL) from external MIDI equipment.

What the MIDI can do on your Organ

On this organ, the MIDI terminals are intended to do the following:

- ♦ control an external sound generator such as synthesizer or sampler.
- ♦ record or playback your performance to an external computer or sequencer.

The “MIDI Template” feature allows you to quickly set up the organ for specific MIDI applications.

MIDI CHANNEL

A “MIDI Channel” is the avenue along which MIDI information is sent and received. It is similar in principle to television channels. Up to 16 MIDI Channels can be sent or received.

In order for MIDI communication to take place, the transmitting and receiving instruments must be set to the same channel - for instance, if one instrument is sending out MIDI data on MIDI Channel 1, the receiving instrument must also be set to MIDI Channel 1.

CHANNEL MESSAGE

◆ NOTE Data

MIDI Note data is made up of four components: Note Number (the specific key or pitch to play), Note On (telling the note to start playing), Note Velocity (the loudness of the note) and Note Off (telling the note to stop playing).

◆ PROGRAM CHANGE

MIDI uses “Program Numbers” to tell the receiving instrument what sound or tone to play.

SWELL and GREAT CHANNEL:

Uses Program Numbers to select different Preset Keys.

EXTERNAL ZONE CHANNEL:

Switches the program of the External MIDI equipment.

◆ CONTROL CHANGE

“Control Numbers” are used to control devices such as an Expression Pedal, Foot Switch, etc.

SYSTEM MESSAGE

◆ SYSTEM EXCLUSIVE MESSAGE

These messages are for sending and receiving characteristic data between the same model or products made by the same manufacturer.

On this organ, the MEMORY DUMP feature can be used to send and receive all current settings. In this way, you can record song data to an external MIDI sequencer along with registration data so that the song will play correctly.

MIDI STRUCTURE

This organ has a “Keyboard Channel” for transmitting (sending/receiving) the playing information of each manual as well as an “External Zone Channel” for controlling an external MIDI equipment.

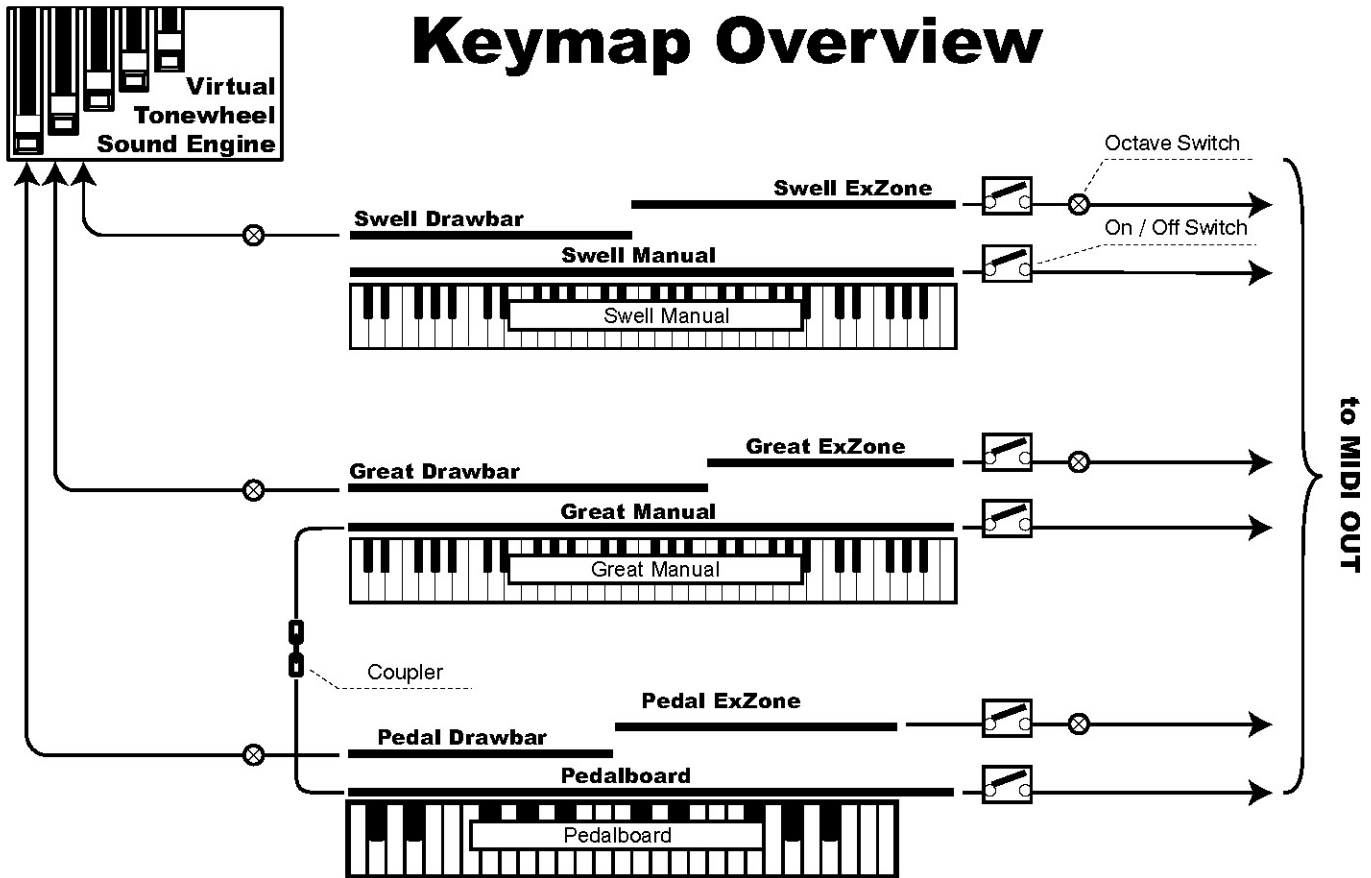

◆ KEYBOARD CHANNELS

These are for sending and receiving SWELL, GREAT, and PEDAL keyboard performance and control information.

Thus the Keyboard Channels respond to both MIDI IN and MIDI OUT.

Use these channels for exchanging playing information with an external sequencer.

◆ EXTERNAL ZONE CHANNELS

These channels are for controlling external MIDI equipment using this organ as a master keyboard.

These channels are MIDI OUT only - no MIDI IN information is recognized.

You can save different configurations and Program Changes in the Presets.

This is the method to record and play back your performance by connecting a Sequencer or Computer to your organ.

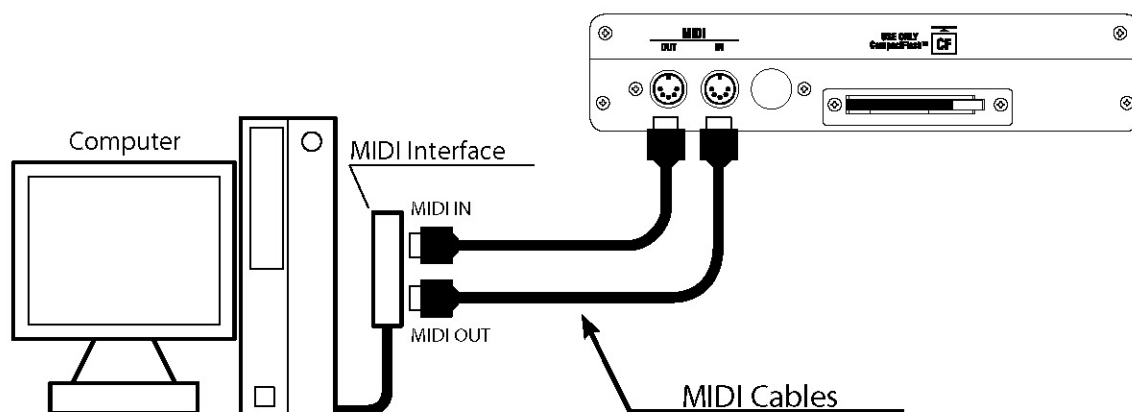

◆ Recording to the Sequencer or the Computer

1. Hook up as illustrated.
2. Use the "MIDI Template" feature to recall either "Seq.Local" or "Seq.No Local" (P. 94 #1).
Select "Seq. Local" if you do not use the "Echo" (or "MIDI Thru") function of the external sequencer, or select "Seq. No Local" if you use it.
3. Set the Keyboard Channel that you wish to use.
Set the MIDI channel of the external sequencer to the same channel as the organ.
4. Start the Sequencer recording.
5. Send the Memory Dump (if desired).
6. Start playing.

◆ Playback from the Sequencer or the Computer

1. Hook up as illustrated.
2. Use the "MIDI Template" feature to recall either "Seq.Local" or "Seq.No Local."
3. Set the Keyboard Channel that you want.
Set the MIDI channel of the external sequencer to the same channel as the organ.
4. Start the Sequencer playing.

USING A MIDI COMPATIBLE LESLIE SPEAKER

If you connect this organ and the Leslie speaker through MIDI, you can send the Leslie parameters such as the rotor speed and the rise time to the Leslie speaker and can make finer adjustment than connecting only with the Leslie cable.

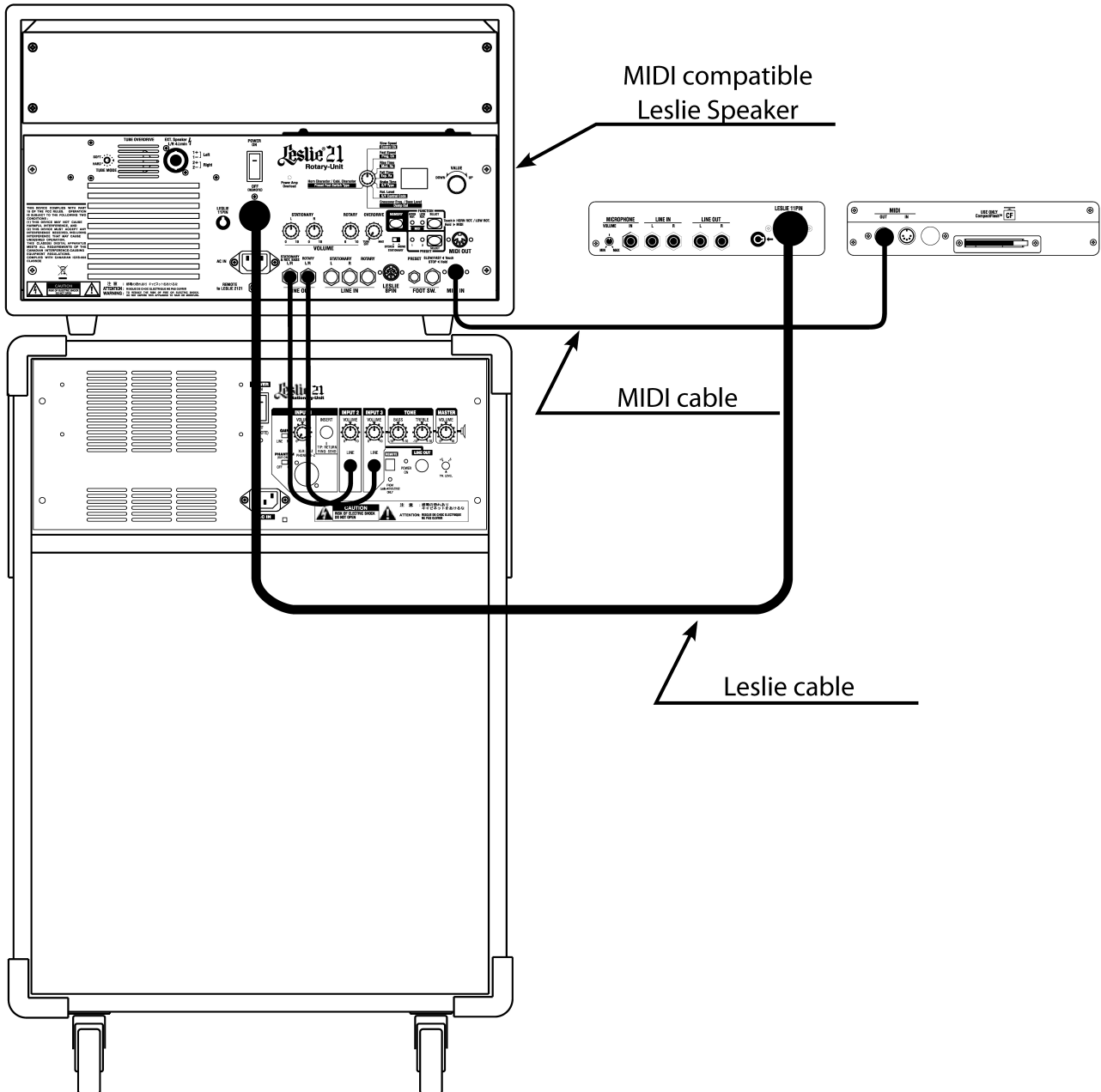

1. Hook up as illustrated.
2. Use the "MIDI Template" feature to recall "Leslie" (P. 94 #1).
3. Set the Leslie MIDI Channel (P. 95 #14).

Set the Leslie MIDI channel of the organ at the same value as the Leslie speaker MIDI channel.

4. If you operate the Leslie parameters on this organ or call out the SWELL Presets, these Leslie parameters are sent to the Leslie speaker.

tips MIDI COMPATIBLE LESLIE SPEAKER

Current models are Leslie #2101, 2102, 2103, 2101 mk2, 2103 mk2.

You can control external MIDI equipment with a zone for each of the SWELL and GREAT manuals and Pedalboard.

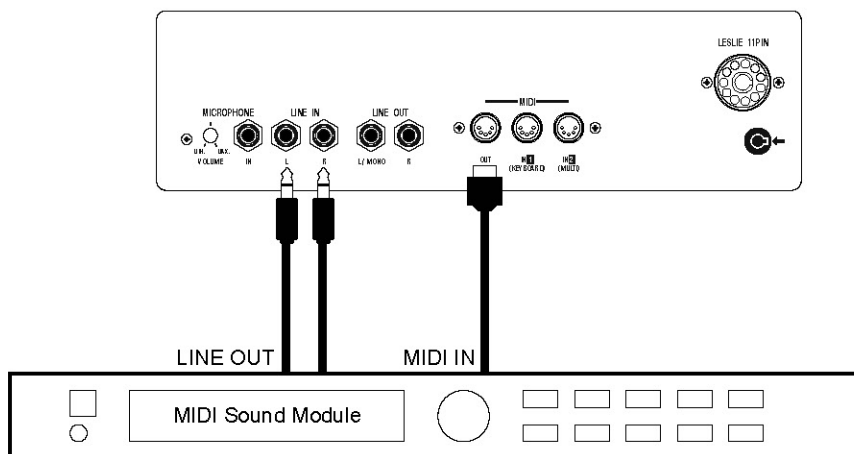

1. Hook up as shown above.

Connect the MIDI OUT of this organ to the MIDI IN of the equipment you want to control.

2. Use the "MIDI Template" feature to recall "Seq. Local" (P. 94 #1).

3. Select a Preset Bank.

4. Set the Transmit Internal at OFF, and External at ON (P. 65).

By this, the transmission of the Keyboard Channel stops and the information of the External Zone is sent from MIDI OUT.

The ON/OFF settings of the Keyboard Channels and External Zones can be set for each Preset Bank.

5. Set the Zone, and the data that is to be recorded to the Combination Preset, if necessary.

See "ZONES" on the next page for how to set the Zones.

MIDI

tips NOTE ON THE SOUNDING POINT

The External Zone sounds at a little deeper point of the key than the Drawbar tone.

This is for outputting the velocity data to the External Zone.

ZONES

The EXTERNAL ZONES allow you to use the SWELL and GREAT manuals and the Pedals to control external MIDI equipment independently of the Drawbars.

The INTERNAL ZONES (or Keyboard Channels) are for sounding Drawbar Voices. They can layer or split with EXTERNAL ZONES.

▼PXZ CH OCT LO--HI ZONE 6 +0 1C 6C ▶	▼PXZ M-BNK-L PROG PROG◀ 0 0 1 ▶	▼PXZ VOL PAN VEL NOTE◀ 100 -C- OFF ▶
↕GXZ CH OCT LO--HI ZONE 4 +0 1C 6C ▶	↕GXZ M-BNK-L PROG PROG◀ 0 0 1 ▶	↕GXZ VOL PAN VEL NOTE◀ 100 -C- 1 ▶
↕SXZ CH OCT LO--HI ZONE ④ ①⑤ +0 ⑥ 1C ⑦ 6C ▶	↕SXZ M-BNK-L PROG PROG◀ ⑧ 0 ⑨ 0 ⑩ 1 ▶	↕SXZ VOL PAN VEL NOTE◀ ⑪ 100 ⑫ -C- ⑬ 1 ▶
↕PDB OCT LO--HI ZONE +0 1C 6C		
↕GDB OCT LO--HI ZONE +0 1C 6C		
▲SDB OCT LO--HI ZONE ① +0 ② 1C ③ 6C		

◆ Items in the top left corner

The current ZONE you are editing is displayed in the top left corner of the Zone mode.

- SDB: SWELL Internal Zones (Drawbars)
- GDB: GREAT Internal Zones (Drawbars)
- PDB: PEDAL Internal Zones (Drawbars)
- SXZ: SWELL External Zone
- GXZ: GREAT External Zone
- PXZ: PEDAL External Zone

◆ INTERNAL ZONES

① ZONE - OCTAVE

This sets the octave the Drawbar sound engine produces.
Setting Range: -2 to +2.

② ZONE - LO

③ ZONE - HI

These set the playing range of the Drawbars on each of the SWELL and GREAT manuals and Pedals.

NOTE: You can also set the value by touching and holding the [JUMP/STORE] button, while holding down the desired note on the manual (or pedalboard).

◆ EXTERNAL ZONES

④ MIDI CHANNEL

This is for selecting on which MIDI Channel the External Zone will transmit.

The range is 1 - 16, and OFF.

⑤ NOTE - OCTAVE

This is for selecting the octave to be transmitted by this zone.
The octave that is transmitted may be set to be different than the octave that you may be playing.

⑥ ZONE - LO

⑦ ZONE - HI

These set the playing range of the selected External Zone on

To locate this mode:

1. From either of the PLAY screens, touch the [MENU/EXIT] button. Menu A will display.
2. Touch the [PAGE ▲] button three times. Menu D will display.
3. Touch the [1] ZONES button.

each of the SWELL and GREAT manuals and Pedals.

Set the lowest note at LO and the highest one at HI. To prevent note data from being transmitted, set the HI parameter to "OFF".

NOTE: For 6 and 7, you can set the value by touching the [JUMP/STORE] button, while holding down the desired note on the manual (or pedalboard).

⑧ PROGRAM - BANK MSB

⑨ PROGRAM - BANK LSB

⑩ PROGRAM - PROGRAM CHANGE

These are for setting the Bank Select and the Program Change data to be transmitted by this zone.

NOTE: These numbers are frequently different from one instrument to another, and there may be some which are unique to one particular MIDI instrument. Please consult the User Manual for each MIDI instrument you wish to use, as there will usually be a chart listing the Program Number assignments for each voice or patch.

You can choose 0 - 127 in the Bank MSB and the Bank LSB, and 1 - 128 in the Program Change.

⑪ NOTE - VOLUME

This is for setting the volume (= Control Change #7) of this zone.

NOTE: If the CC# (item #16) is set at "7.VOL," this value will be overridden.

⑫ NOTE - PAN

This is for setting the Pan (= Control Change #10) of this zone.

⑬ NOTE - VELOCITY

This is for setting the Velocity Curve to send to this zone.

The setting range is OFF, 1 - 4. The velocity of OFF is fixed at 100. At 1 - 4, the higher the value increases, the higher velocity is transmitted regardless how the key is played.

▼PXZ MIN-MAX	CC#
EXP. ◀ 40 127	11:EXP
⚡GXZ MIN-MAX	CC#
EXP. ◀ 40 127	11:EXP
⚡SXZ MIN-MAX	CC#
EXP. ◀ 40 127 11:EXP	

NOTE: The velocity of the PEDAL External Zone (PXZ) is fixed at OFF since the Pedalboard of this organ has no velocity sensing function.

④ EXPRESSION - MINIMUM

⑤ EXPRESSION - MAXIMUM

These allow you to widen or narrow the volume range of the Expression Pedal for the External Zones.

NOTE: These settings DO NOT affect the internal organ (Drawbar) tones.

With many types of external sound gear, the volumes do not react the same. This parameter allows a smooth and equal flow in the Expression Pedal.

You can select 0 - 63 by MIN, and 64 - 127 by MAX.

⑥ EXPRESSION - CONTROL NUMBER

This is for setting the MIDI continuous Control Number of the Expression Pedal.

Depending on your external equipment, it may respond to CC#7 (Volume) or CC#11 (Expression). This parameter allows you to make that choice.

NOTE: All the parameters in these modes are Preset Parameters. They can be recorded to the Combination Presets. See the Appendix for details of the Preset Parameters.

◆ PANIC FUNCTION and PARAMETER RE-LOAD

If any problem happens in the MIDI system, it may cause ciphering (sticking notes). Immediately after external MIDI equipment is connected to this organ, a glitch or “MIDI hang-up” may occur. Also with some MIDI equipment a note may occasionally cipher or “stick on” while playing.

If this occurs, touch PAGE[▲] and [▼] at the same time. [All Notes Off] and [Reset All Controller] will be transmitted to all External Zone MIDI channels (Panic Function) and all the External Zone settings will be re-sent.

tips

ACTIVATE THE EXTERNAL ZONE CHANNELS

If you wish to use the External Zones, be sure that the SWITCH setting for each External Zone you wish to use is “ON.” (P. 65 #18-19).

This adjusts the basic settings of the MIDI.

To locate this mode:

1. From either of the PLAY screens, touch the [MENU/EXIT] button. Menu A will display.
2. Touch the [PAGE p] button four times. Menu E will display.
3. Touch the [1] MIDI button.

↙CH SWL GRT PDL KBD ①1 ②2 ③3 ▶	↙CH LES ↓OFF④	
↕MAST LOCAL NRPN LES ②ON ③OF ④OR▶	↕MAST PROG REGI Tx&Rx⑤ OFF ⑥OFF ▶	↕MAST ID RECV. DUMP ⑦1 ⑧ON ▶
▲TEMPLATE ①Seq. Local ▶[RECL]	▲TEMPLATE ①Seq. No Local▶[RECL]	▲TEMPLATE ①Leslie [RECL]

◆ MIDI TEMPLATE

① MIDI TEMPLATE

This is a preset mode enabling you to quickly set up various MIDI configurations.

Typical settings can be recalled by touching the [PARAM] button to select the template and touching [4] RECL.

See “MIDITEMPLATE” in the Appendix (P. 109) for details of each MIDI template.

◆ MASTER

② LOCAL

This is for switching the Local Control “ON” or “OFF” (internal).

When “ON,” the keyboard of this organ and the sound engine are connected.

When “OFF,” the internal sound engine is disengaged from the keyboards and pedalboard. This allows you to play an external module while a sequencer plays the internal engines of the organ.

③ NRPN

This is for switching ON/OFF the transmission of (= send and receive) NRPN (Non-Registered Parameter Number).

On this organ, it switches whether to send / receive messages such as Drawbar Fold-Back, Leslie ON, etc.

When “ON,” the message is sent/received. When “OFF,” it is not.

④ LESLIE

This is for controlling how to send Leslie Parameters.

The Leslie Parameters are sent on the Leslie Channel.

OR:

The Leslie Parameters will be sent out with the original NRPN codes.

21:

The Leslie Parameters will be sent out for Leslie 21 series NRPN address and data.

When the Cabinet Number is selected (e.g. by Preset Key), the Leslie Parameters are sent out also.

⑤ PROGRAM CHANGE

Switches the sending and receiving of the Program Change/Bank Select by the Keyboard Channel. On this organ, Program and Bank Changes for the Keyboard Channel are sent by switching Preset Banks and Preset Keys.

⑥ DRAWBAR REGISTRATION

Switches the sending and receiving of Drawbar Registrations by the Keyboard Channel.

⑦ DEVICE ID

This sets the Device ID for sending/receiving the system exclusive messages such as Memory Dump.

The setting range is 1 - 32.

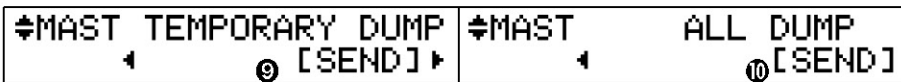

8 RECEIVE DUMP

This is for determining whether or not to receive the Memory Dump.

You can use the MEMORY DUMP feature to transmit and receive the current settings via System Exclusive data, but you must set this switch to “OFF” if you do not want the settings of this organ to be changed.

When “ON,” the organ will receive an incoming Memory Dump. When “OFF,” it will not.

9 TEMPORARY DUMP

This is for sending the Memory Dump.

If you touch [4] SEND in this page, this organ sends the whole TEMPORARY (= the current setting information) data from the MIDI OUT jack. This is for recording the TEMPORARY data to an external MIDI Sequencer.

10 ALL DUMP

If you touch [4] SEND in this page, this organ sends ALL data from the MIDI OUT jack. This is for recording ALL data to an external MIDI Sequencer.

◆ CHANNELS

These are for setting which MIDI Channel you use to send / receive on each keyboard. You can choose 1 - 16 and OF. If OF, no MIDI data is sent or received.

11 SWELL

This is for setting the MIDI channel to send and receive the playing information of the SWELL manual, as well as other playing controls such as buttons, knobs and the Expression Pedal.

12 GREAT

This is for setting the MIDI channel to send and receive the playing information of the GREAT manual.

13 PEDAL

This is for setting the MIDI channel to send and receive the playing information of the Pedalboard.

14 LESLIE

This is for setting the MIDI channel to send and receive the Leslie parameter information.

❖ *To avoid confusion of the MIDI signals, be careful not to duplicate each MIDI channel, including the External Zone (P. 92 #4).*

NOTE: The parameters 2 to 8, 11 to 14 are System parameters. They are not recorded into the Presets and are common with all Presets.

tips CONTENT OF TEMPORARY DUMP

TEMPORARY DUMP will transmit PRESET Parameters, GLOBAL Parameters and SYSTEM Parameters (the current status of the playing controls).

ALL DUMP, in addition to the above, will transmit the content of each Combination Preset, Custom Tone Wheels and Custom Leslie Cabinets.

tips ACTIVATE THE KEYBOARD CHANNELS

If you wish to use the Keyboard Channels, be sure that the SWITCH setting for each Keyboard Channel you wish to use is “ON.” (P. 65 #18-19).



SAVE THE SETUP

On this organ you can save the setting of each Parameter as a file called a "SETUP." You can then save the Setup to a CompactFlash™ Card (hereinafter "CF card").

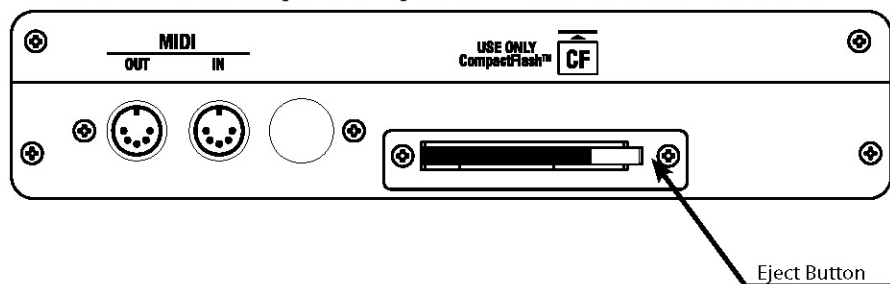

About CF Card

◆ RECOMMENDED CF CARDS

The manufacturer recommends you use genuine Hammond CF Cards (#65971-02128).

Please consult <http://www.hammondorganco.com> before you try to use other cards in this organ.

◆ CF CARD SLOT

1. Be sure to read the label on the CF Card carefully and insert it correctly.
2. To remove the card, push the Eject Button on the right side of the slot.
3. Do not eject the card or switch the power off during initializing or setup.

◆ THE CONTENT AND CAPACITY TO BE SAVED

The CF card can save:

- ◆ Presets
- ◆ Global Parameters
- ◆ Custom Tone Wheels
- ◆ Leslie Cabinets
- ◆ Adjust Presets (the "B" Preset Keys)
- ◆ Temporary Parameters

Also, as mentioned above you can save all of the above parameters as a SETUP.

The capacity of one SETUP is approximately 44 KB.

INITIALIZE THE CF CARD

The CF Card must be "INITIALIZED" before you use it. Perform the following, step by step, to do the initialize operation.

❖ This operation erases all data in the CF Card.



Insert the CF Card into the slot.

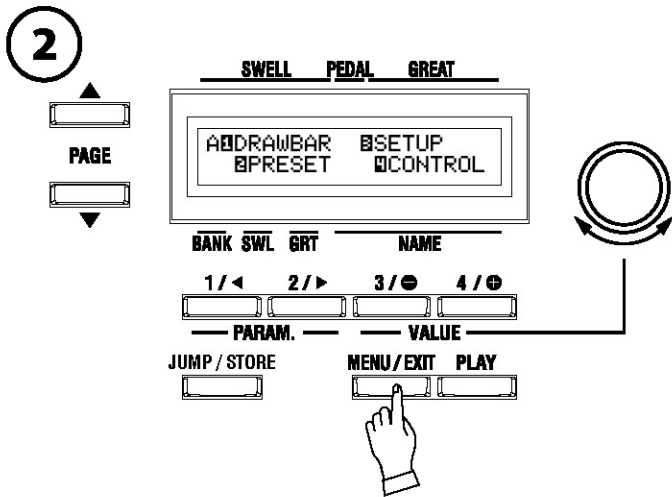

Touch the [MENU] button to display the menu.

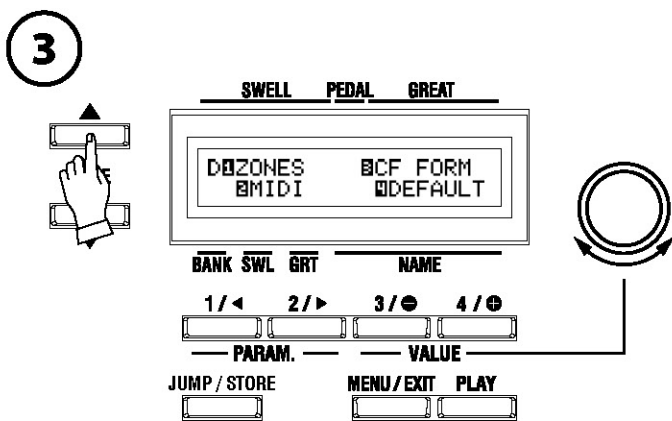

Touch the [PAGE] button to select Page D.

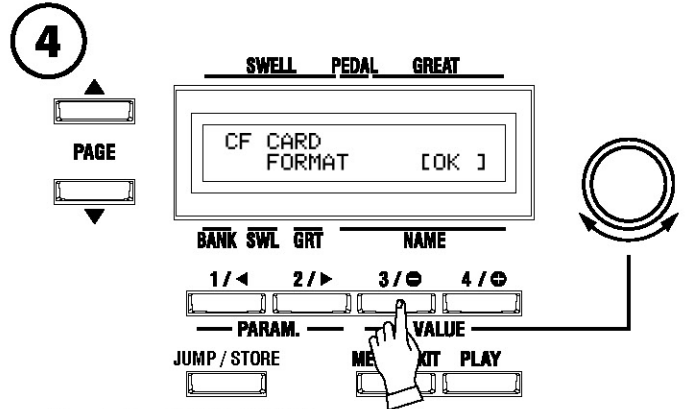

Touch the [3] CF FORM.
The FORMAT mode is displayed.

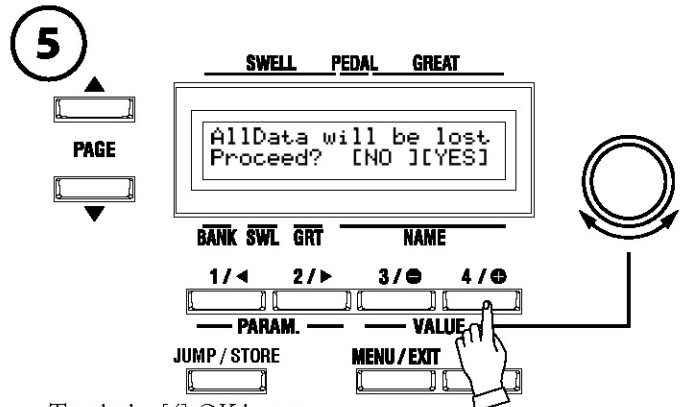

Touch the [4] OK button.
The confirmation message is displayed.

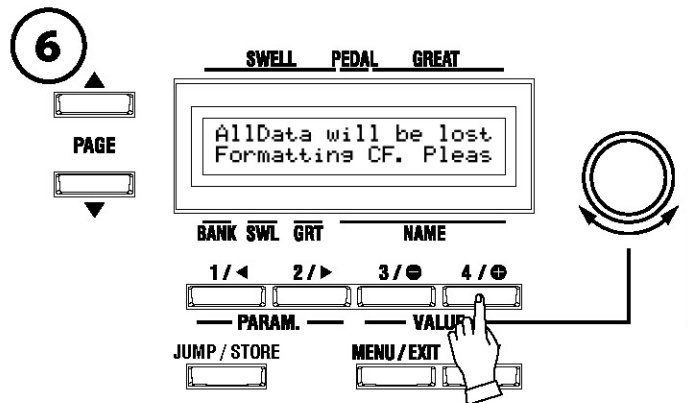

Touch the [4] YES button.
After approximately 3 seconds, the CF card will be initialized.
NOTE: If you do not want to initialize, touch the [3] NO button.



To return to the PLAY mode, touch [PLAY].

Save the Setup

SETUP MODE

The SETUP mode allows you to Save or Load SETUPs to/from a CF card. In this mode, you can do all the operations except the initialization of the CF card.

To locate this mode:

1. From either of the PLAY screens, touch the [MENU/EXIT] button. Menu A will display.
2. Touch the [3] SETUP button.

How to read the display

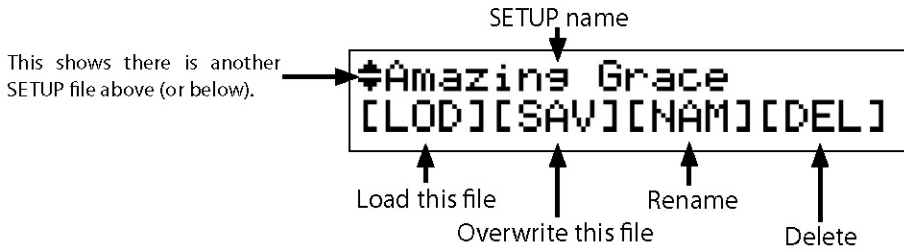

Save the Setup

1
Check that the CF Card is correctly inserted.

2
Amazing Grace
[LOD][SAV][NAM][DEL]

Go to the Setup mode.

What does this mean?

- CF is not ready
- The CF Card is not correctly inserted.

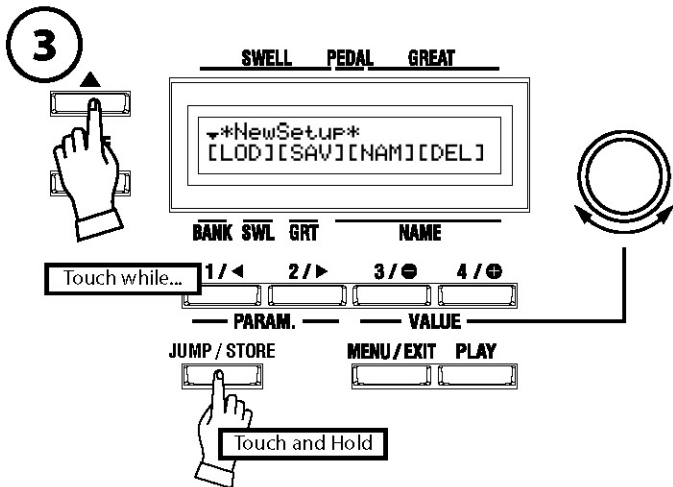

Select the Setup name "New Setup" by the [PAGE] button.
NOTE: "New Setup" means a fresh save. If you select an existing Setup name, it will be deleted and overwritten (= renewed).

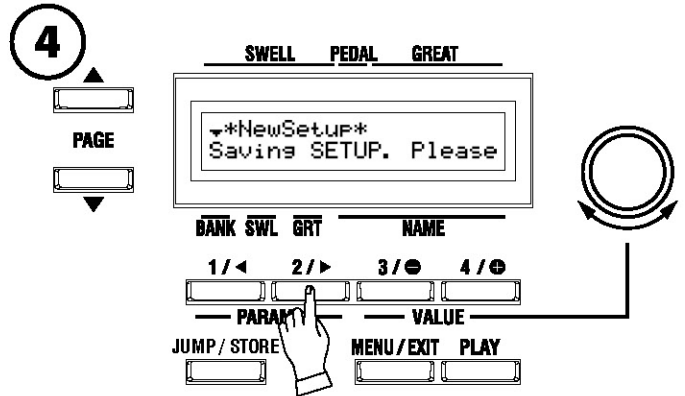

Touch the [2] SAV button.

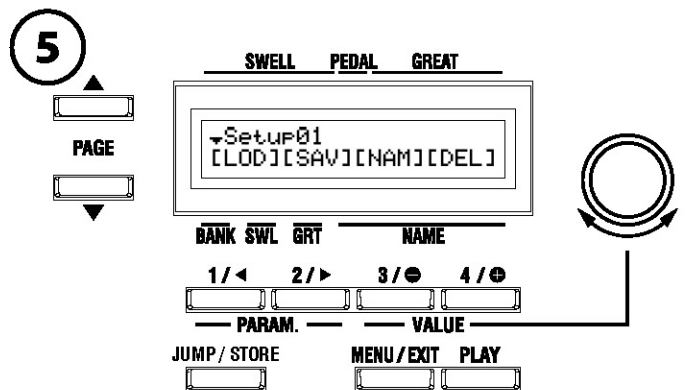

A temporary name is automatically given to the saved Setup, such as "Setup xx."

Change the SETUP Name

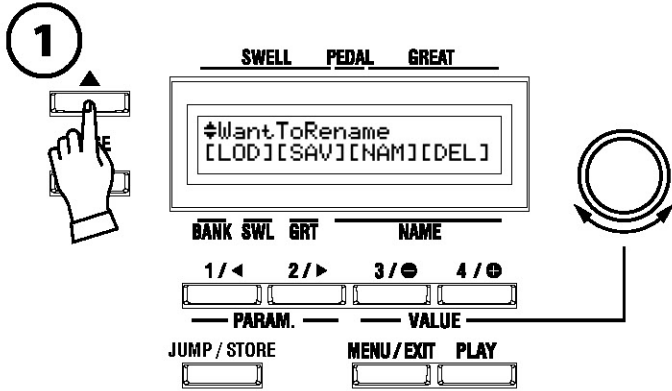

Select the Setup file you want to rename.

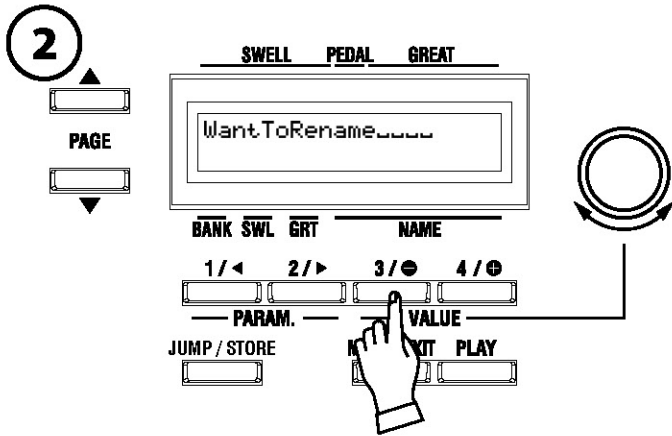

Touch the [3] NAM button.

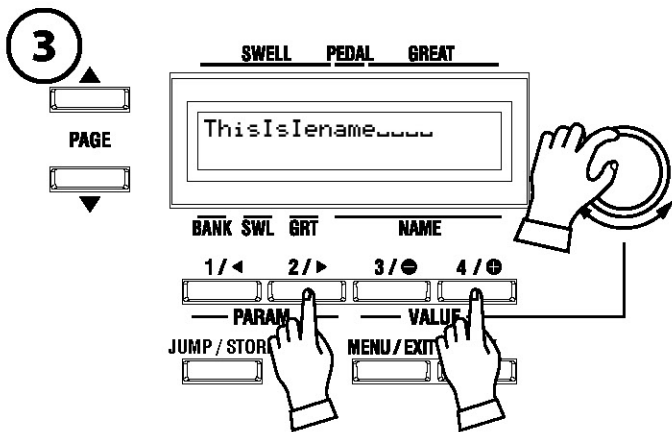

Input the new Setup name.

[PARAM] buttons

Use these buttons to move the cursor.
You can use up to 16 letters.

[VALUE] buttons

Use these buttons to select the letters.
The available characters include upper- and lower-case letters (A ~ Z, a ~ z), numbers (0 ~ 9) and punctuation marks and symbols.
If you touch a [VALUE] button, holding down the [JUMP] button, you can move to the first letter of each type (= space, 0, A, a)
The [VALUE] knob can also be used to choose characters.

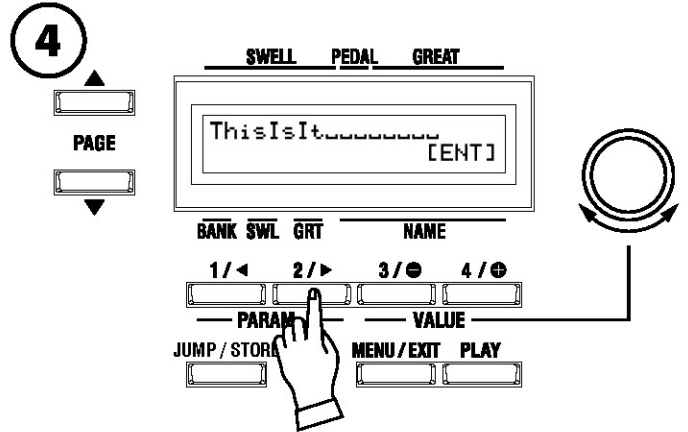

Use the [PARAM] button to scroll to the end of the name.
[ENT] will be displayed.

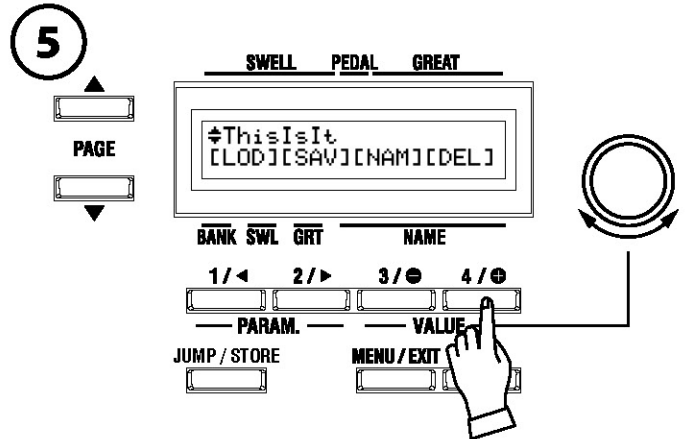

Touch the [4]ENT button.
The Setup name will be changed.

Load the Setup

❖ When you load a Setup from a CF card, the current settings are overwritten with the settings from the new Setup. Therefore, if the current Setup contains information you don't want to lose, it is highly recommended that you back up the existing Setup to a CF card so that you have a permanent record of it.

1

Make sure the CF card is correctly inserted.

2

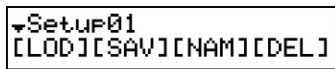

Enter SETUP mode.

3

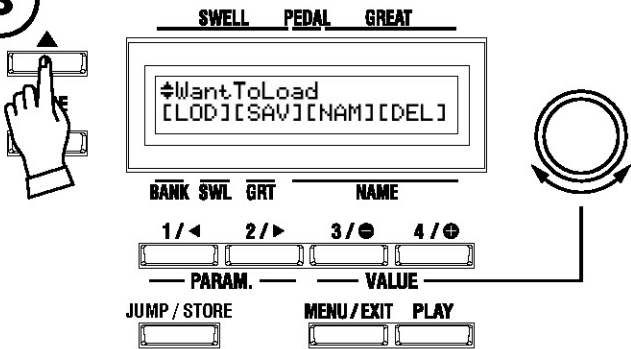

Choose the Setup file to load by the [PAGE] button.

4

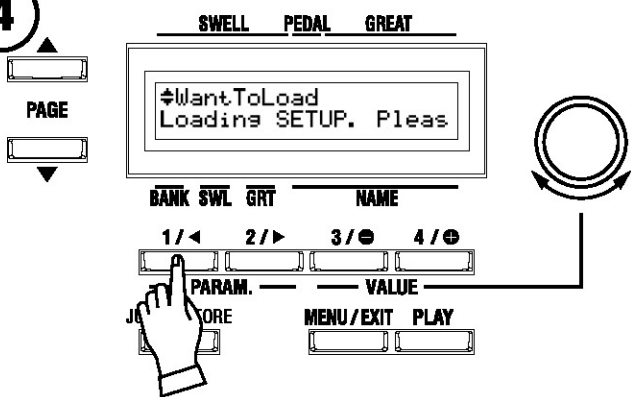

Touch the [1] LOD button.

After approximately 3 seconds, the Setup will be loaded into the organ.

How To Delete the Setup

1

Make sure the CF Card is correctly inserted.

2

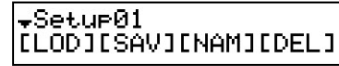

Enter SETUP mode.

3

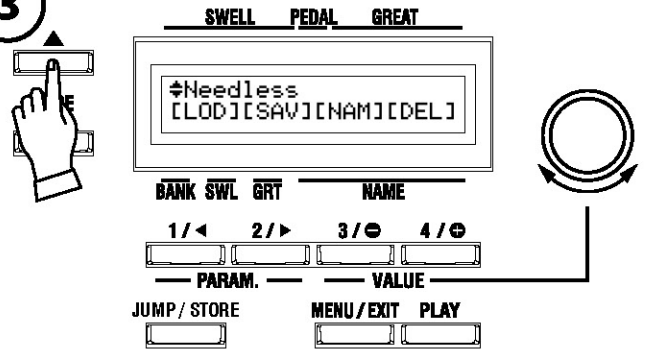

Choose the Setup file you want to delete by the [PAGE] button.

4

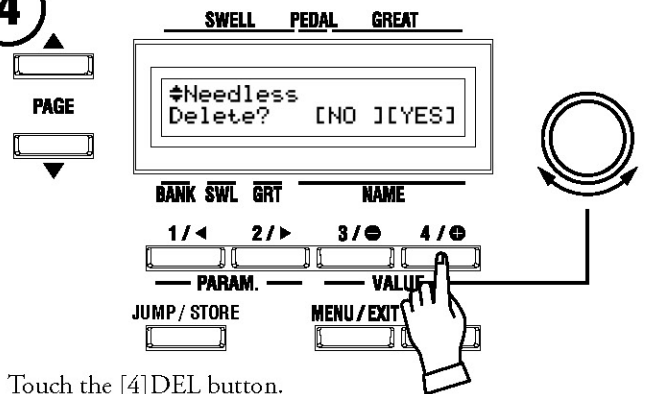

Touch the [4]DEL button.

You will be asked to confirm whether you want to delete the Setup.

5

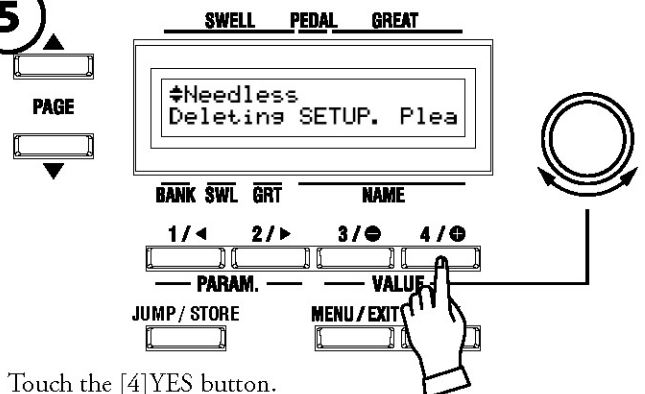

Touch the [4]YES button.

After approximately 3 seconds, the Setup will be deleted.

NOTE: If you do not want to delete the data, touch the [3]NO button.

A decorative graphic consisting of a thick black line that starts as a swirl on the left, loops around, and then forms a large circle. Inside the circle, the text "FREQUENTLY ASKED QUESTIONS" is written in bold, black, uppercase letters.

**FREQUENTLY
ASKED
QUESTIONS**

- ◆ Malfunction of the buttons, the keys, etc.
 - ◆ Turn the POWER Switch “OFF” once, then turn it back “ON.” If this procedure is not successful, turn the POWER Switch “OFF” While touching the [RECORD] button, turn the POWER Switch “ON” again. (Note that in this case, all parameters return to their factory-preset status.)
- ◆ No sound is produced when keys are pressed and a Preset is selected.
 - ◆ The MASTER VOLUME is at the minimum setting. ⇨
Adjust the volume with the MASTER VOLUME control. (P. 12 #2)
 - ◆ A plug is inserted into the HEADPHONE jack. ⇨
While a plug is inserted here, the internal speakers as well as a connected Leslie Speaker are disabled.
- ◆ The Foot Switch does not work.
 - ◆ The Foot Switch settings are not correct. ⇨
Reset the Foot Switch correctly in the CONTROL mode. (P. 66 #21)
- ◆ The rotor of the external Leslie speaker does not stop, if the Leslie off mode is switched to [BRAKE].
 - ◆ Some Leslie Speaker models do not [BRAKE]. [BRAKE] is possible on 2101/2102(mk2), 122XB, 971, 981 and 3300 (current models).
- ◆ Audio is interrupted when a Preset is selected.
 - ◆ If you switch between Combination Presets with different Custom Tone Wheel Settings, the sound will be momentarily interrupted while the Custom Tone Wheel Settings are switched.
 - ◆ When you switch between Presets having different Internal/External Zone settings or different PEDAL Mode settings while holding down playing keys, the audio is switched “off,” but will sound again when keys are pressed after selecting the new Preset.

◆ AC Power

Be sure to turn the instrument "OFF" after use, and do not turn the unit "ON" and "OFF" in quick succession, as this places an undue load on the electronic components.

◆ Cabinet And Bench

As with any piece of furniture, direct sunlight can damage the finish of your instrument. Use a soft dry cloth for dusting. To remove fingerprints or dulling film, use a soft cloth slightly moistened with water and a little mild soap. Immediately wipe dry with a soft dry cloth.

◆ Keys And Buttons

To clean keys and buttons, use a clean soft cloth moistened with water. Do not use any solvents, thinners or dryers such as alcohol, gasoline, lighter fluid, carbon tetrachloride, etc. These solutions may affect the letters and/or finish on the buttons and keys.

◆ Moving Your Instrument

It is not necessary to bolt or fasten any parts of the instrument when moving. Careful consultation with your mover will assure you of a satisfactory moving job.

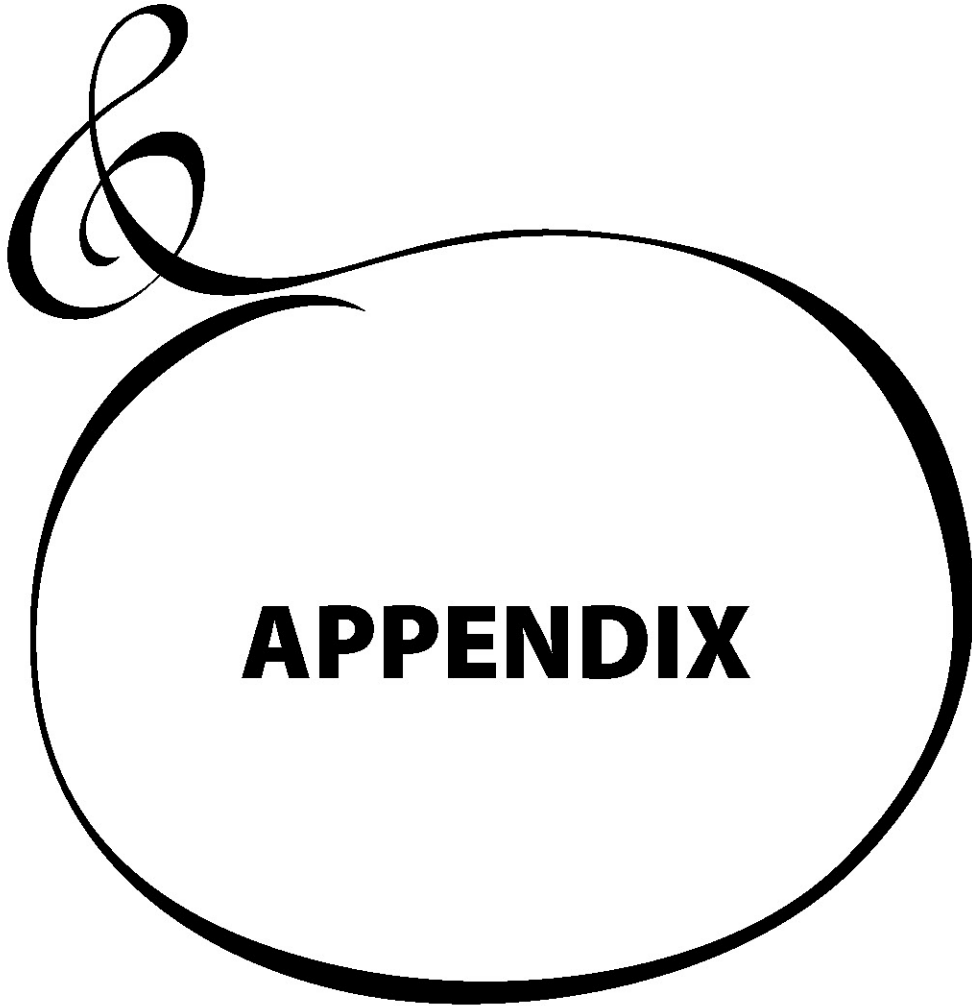

BType1, BType2**Real B-3**

This preset faithfully simulates the classic model, B-3. It contains low motor hum and some leakage noise.

80's Clean

This preset simulates the B-3 sounds in the 80's. It contains reduced leakage noise.

Noisy

This preset is for passing all sounds picked up by the magnets on each tone wheel. It contains full motor hum and leakage noise.

Noisy 60

This preset boosts noise sounds. It contains full motor hum and leakage noise.

A-100

This preset simulates the A-100.

Mellow**Full Flats**

This preset simulates the most ideal tone wheel set. The values are the same at each wheel.

Husky

This preset has the characteristic of a lower middle range.

Flute Lead

This preset has the characteristic of lower bass and treble, contrasting "Husky".

Brite**Classic X-5**

This preset faithfully simulates the classic model, X-5. It contains a dull triangle waveform and flat output levels on every wheel.

Voxy Full

This preset has the brightest sounds. It is suitable for surf and oldies music.

Cheap Tr. s

This preset simulates an old transistor organ. It has a limited sonic range.

Saw**Farf. Norm**

This preset faithfully simulates the classic Farf. organ. It contains a dull sawtooth waveform and flat output levels on every wheel.

Farf. Boost

This preset is similar to Farf. Norm, but with extended high-frequency response.

Cheap Tr. s

This preset simulates an old transistor organ. It has a limited sonic range.

Template		Seq. Local	Seq. No Local	Leslie
Messages	Local Control	On	Off	On
	NRPN	On	On	On
	Drawbar Registration	On	On	On
	Program Change	On	On	On
	Leslie Control Code	Organ	Organ	Leslie 21
Transmit Channel	SWELL manual	1	1	1
	GREAT manual	3	3	3
	Pedalboard	5	5	5
	Leslie	Off	Off	1
Comments	Use this template for connecting the organ to an external MIDI sequencer <u>without</u> the "Echo Back" (or MIDI thru) function, and recording songs.		Use this template for connecting the organ to an external MIDI sequencer <u>with</u> the "Echo Back" (or MIDI thru) function, and recording songs.	Use this template for connecting a Leslie 21 speaker with MIDI and 11 pin cable.

CHANNELS AND MIDI MESSAGES

	External Zone (Tx. only)	SWELL Keyboard	GREAT Keyboard	PEDAL Keyboard	Leslie Speaker
Note	○	○	○	○	X
Pitch Bend	X	X	X	X	X
Modulation (1)	X	X	X	X	X
Volume, Pan (7, 10)	○	X	X	X	X
Expression (11)	○	○ *1	X	X	X
Hold 1 (64)	○	○	○	○	X
Drawbar Reg. SWELL: 12 - 20 GREAT: 21 - 29 PEDAL: 33,35	X	○	X	X	X
Spring Shock (48)	X	○	X	X	X
RPN (100, 101)	X	X	X	X	X
NRPN (98, 99)	X	○	X	X	○
All Notes Off (123)	○	○	○	○	X
All Sounds Off (120)	X	○ *2	○ *2	○ *2	X
Reset All Control (121)	○	○	○	○	X
After Touch	X	X	X	X	X
Bank Select (0, 32)	Change the voice for each zone.	○	X	X	X
Program Change		○	○	X	X

*1: It works for all parts (audio controlled)

*2: For Rx. only.

MIDI Implementation

◆ Channel Voice Message

Note Off

Status	2nd Byte	3rd Byte
8nH	kkH	vvH, or
9nH	kkH	00H
n=MIDI Channel Number:	0H - FH (Ch. 1 - 16)	
kk=Note Number:	00H - 7FH (0 - 127)	
vv=Velocity(disregard):	00H - 7FH (0 - 127)	

Note On

Status	2nd Byte	3rd Byte
9nH	kkH	vvH
n=MIDI Channel Number:	0H - FH (Ch. 1 - 16)	
kk=Note Number:	00H - 7FH (0 - 127)	
vv=Velocity:	00H - 7FH (0 - 127)	

Control Change

The value set by the Control Change is not reset even when Program Change messages etc. are received.

Bank Select (CC#0, 20)

Status	2nd Byte	3rd Byte
BnH	00H	mmH
BnH	20H	llH
n=MIDI Channel Number:	0H - FH (Ch. 1 - 16)	
mm,ll=Bank Number:	00 00H - 7F 7FH	

Until you send the Program Change, the Bank Select process is reserved.

Modulation (CC#1)

Status	2nd Byte	3rd Byte
BnH	01H	vvH
n=MIDI Channel Number:	0H - FH (Ch. 1 - 16)	
vv=Modulation Depth:	00H - 7FH (0 - 127)	

Expression (CC#11)

Status	2nd Byte	3rd Byte
BnH	0BH	vvH
n=MIDI Channel Number:	0H - FH (Ch. 1 - 16)	
vv=Expression:	00H - 7FH (0 - 127)	

Spring Shock (CC#48)

Status	2nd Byte	3rd Byte
BnH	30H	vvH
n=MIDI Channel Number:	0H - FH (Ch. 1 - 16)	
vv=Velocity:	00H - 7FH (0 - 127)	

Damper (CC#64)

Status	2nd Byte	3rd Byte
BnH	40H	vvH
n=MIDI Channel Number:	0H - FH (Ch. 1 - 16)	
vv=Control Value:	00H - 7FH (0 - 127)	
	0 - 63=Off, 64 - 127=On	

NRPN MSB/LSB (CC#98, 99)

Status	2nd Byte	3rd Byte
BnH	63H	mmH
BnH	62H	llH
n=MIDI Channel Number:	0H - FH (Ch. 1 - 16)	
mm=upper byte of the parameter number specified by NRPN		
ll=lower byte of the parameter number specified by NRPN		

Data Entry (CC#6, 38)

Status	2nd Byte	3rd Byte
BnH	06H	mmH
BnH	26H	llH
n=MIDI Channel Number:	0H - FH (Ch. 1 - 16)	
mm,ll=the value of the parameter specified by NRPN		

Program Change

Status	2nd Byte
CnH	ppH
n=MIDI Channel Number:	0H - FH (Ch. 1 - 16)
pp=Program Number:	00H - 7FH (prog. 1 - prog. 128)

Pitch Bend Change

Status	2nd Byte	3rd Byte
EnH	llH	mmH
n=MIDI Channel Number:	0H - FH (Ch. 1 - 16)	
mm,ll=Pitch Bend Value:	00 00H - 40 00H - 7F 7FH (-8192 - 0 - +8191)	

◆ Channel Mode Message

All Sounds Off (CC#120)

Status	2nd Byte	3rd Byte
BnH	78H	00H
n=MIDI Channel Number:	0H - FH (Ch. 1 - 16)	

When this message is received, all currently-sounding notes on the corresponding channel will be turned off immediately.

Reset All Controllers (CC#121)

Status	2nd Byte	3rd Byte
BnH	79H	00H
n=MIDI Channel Number:	0H - FH (Ch. 1 - 16)	

When this message is received, the following controllers will be set to their reset values.

Pitch Bend Change:	0 (center)
Expression:	127
Damper:	0
NRPN:	unset; previously set data will not change

All Sounds Off (CC#123)

Status	2nd Byte	3rd Byte
BnH	7BH	00H
n=MIDI Channel Number:	0H - FH (Ch. 1 - 16)	

When All Notes Off is received, all notes on the corresponding channel will be turned off. However if Hold 1 or Sostenuto is ON, the sound will be continued until these are turned off.

Drawbar Data List

Part	Control Number								
	16'	5 1/2'	8'	4'	2 3/4'	2'	1 3/4'	1 1/2'	1'
SWELL	0CH(12)	0DH(13)	0BH(14)	0FH(15)	10H(16)	11H(17)	12H(18)	13H(19)	14H(20)
GREAT	15H(21)	16H(22)	17H(23)	18H(24)	19H(25)	1AH(26)	1BH(27)	1CH(28)	1DH(29)
PEDAL	21H(33)	-	23H(35)	-	-	-	-	-	-

Value	Level								
	0	1	2	3	4	5	6	7	8
	00 - 0FH (0 - 15)	10 - 1FH (16 - 31)	20 - 2FH (32 - 47)	30 - 3FH (48 - 63)	40 - 4FH (64 - 79)	50 - 5FH (80 - 95)	60 - 6FH (96 - 111)	70 - 7EH (112-126)	7FH (127)

ex: Set GREAT 8' to level 7 via MIDI... Bx 17 70 (x = SWELL Channel)

System Exclusive Message

Memory Dump

1. Each Packet

F0	System Exclusive
55	SUZUKI ID
dd	Device ID (refer to P.94 #7)
10	Model ID MSB
21	Model ID LSB
11	Command: Data Packet
[TYPE]	Data Type 02H = All Data Dump 07H = Combi. Temp. Dump 09H = Global Dump 0AH = System Dump
[PNH]	Packet Number MSB
[PNL]	Packet Number LSB
[DATA]	128 Bytes Data 256 Bytes nibblized ASCII ex: 7EH = 37H, 45H
[CHD]	Check Digit Lower 7 bits of XOR [DATA]
F7	End Of Exclusive

2. Acknowledge

F0	System Exclusive
55	SUZUKI ID
dd	Device ID
10	Model ID MSB
21	Model ID LSB
14	Command: Acknowledge
[TYPE]	Data Type
[AK]	Result 00H = OK 05H = Check Digit Error 06H = Receive Protected
[PNH]	Packet Number MSB
[PNL]	Packet Number LSB
F7	End Of Exclusive

3. # of Packets

All Data Dump:	549
Combi. Temp Dump:	4
Global Dump:	4
System Dump:	1

Dump Request (Rx. only)

F0	System Exclusive
55	SUZUKI ID
dd	Device ID
10	Model ID MSB
21	Model ID LSB
12	Command: Dump Request
[TYPE]	Data Type 02H = All Data Dump 07H = Combi. Temp. Dump 09H = Global Dump 0AH = System Dump
F7	End Of Exclusive

◆ NRPN Switch

F0	System Exclusive
55	SUZUKI ID
dd	Device ID
10	Model ID MSB
21	Model ID LSB
02	Command: NRPN Sw.
[DATA]	00H = Off, 7FH = On
F7	End Of Exclusive

When this device receives this message, switch Tx & Rx NRPN in SWELL channel.

◆ Data Set (Rx. only)

F0	System Exclusive
55	SUZUKI ID
dd	Device ID
10	Model ID MSB
21	Model ID LSB
13	Command: Data Set
aa	Address MSB
bb	Address
cc	Address LSB
[DATA]	Data (Flexible bytes)
F7	End Of Exclusive

◆ Identity Request (Rx. only)

F0	System Exclusive
7E	Universal non real-time
dd	Device ID
06	Sub ID #1
01	Sub ID #2
F7	End Of Exclusive

◆ Identity Reply (Tx. only)

F0	System Exclusive
7E	Universal non real-time
dd	Device ID
06	Sub ID #1
02	Sub ID #2
55	SUZUKI ID
00 10	Device Family code
00 21	Device Family number
00 00	
00 00	
F7	End Of Exclusive

When Identity Request is received, Identity Reply will be transmitted.

Global Parameters

Category	Parameter	NRPN		SysEx Address			SysEx Length	Data	Default	Description
		LSB (62)	MSB (63)	MSB to LSB						
Tune	Transpose	01	00	00	01	00	01	3A - 40 - 46 (-6 - 0 - 6)	40	0
	Master Tune	01	02	00	01	02	02	032E - 0338 - 0342 (430 - 440 - 450)	0338	440
Expression	Source	02	00	00	02	00	01	00 - 02 00: Internal 01: MIDI	01	Auto
	Min. Level	02	01	00	02	01	01	00 - 09 (Off, -40dB - 0dB)	06	-35dB
	Min. Limit LF	02	02	00	02	02	01	00 - 08	05	-20dB
	Min. Limit HF	02	03	00	02	03	01	(Off, -40dB - -5dB)	03	-30dB
Foot Switch	FS1 Mode	03	00	00	03	00	01	00 - 0A 00: Off 01: Leslie Fast (alternate) 02: Leslie Fast (momentarily) 03: Leslie Fast (tri-state) 04: Glide 05: Damper SWELL 06: Damper GREAT 07: Damper PEDAL 08: Preset Fwd. 09: Preset Rev 0A: Spring Shock 0B: Delay Time	01	Leslie Fast (alternate)
	FS2 Device	03	01	00	03	01	01	00 - 01 (Foot Sw., Leslie Sw.)	00	Foot Sw.
	FS2 Tip Mode	03	02	00	03	02	01	same as FS1 mode	01	Leslie Fast (alternate)
	FS2 Ring Mode	03	03	00	03	03	01	same as FS1 mode	01	Leslie Fast (alternate)
	Tone Mode	03	04	00	03	04	01	00 - 03 (Tone, Bass, Mid, Treble)	00	Tone
	Damper Drawbars	03	05	00	03	05	01	00, 01 (Off/On)	01	On
	Damper External Zone	03	06	00	03	06	01	00, 01 (Off/On)	01	On
	Panel Switch	Pedal To Great	03	07	00	03	07	01	00, 01 (SWELL/GREAT)	01

Example Set Transpose 0 via NRPN.....Bx 62 01 63 00 06 40 (x = SWELL channel)
 Set Transpose 0 via System Exclusive.....F0 55 dd 10 1D 13 00 01 00 40 F7 (dd = Device ID)

Bank Parameters

Category	Parameter	NRPN		SysEx Address			SysEx Length	Data	Default	Description
		LSB (62)	MSB (63)	MSB to LSB						
Preset Load	Drawbar Regist. SWELL	6b	00	00	6b	00	01	00, 01 (Off/On)	01	On
	Drawbar Regist. GREAT	6b	01	00	6b	01	01	00, 01 (Off/On)	01	On
	Drawbar Regist. PEDAL	6b	02	00	6b	02	01	00, 01 (Off/On)	00	On
	Manual Drawbar Parameters (DB S&G)	6b	03	00	6b	03	01	00, 01 (Off/On)	00	Off
	PEDAL Drawbar Parameters (DB PED)	6b	04	00	6b	04	01	00, 01 (Off/On)	00	Off
	Percussion Parameters (PERCUS)	6b	05	00	6b	05	01	00, 01 (Off/On)	00	Off
	Overdrive (OD)	6b	06	00	6b	06	01	00, 01 (Off/On)	00	Off
	Animation (ANI)	6b	07	00	6b	07	01	00, 01 (Off/On)	00	Off
	Equalizer / Reverb (EQRV)	6b	08	00	6b	08	01	00, 01 (Off/On)	00	Off
	Internal Zone SWELL (IN-S)	6b	09	00	6b	09	01	00, 01 (Off/On)	00	Off
	Internal Zone GREAT (IN-G)	6b	0A	00	6b	0A	01	00, 01 (Off/On)	00	Off
	Internal Zone GREAT (IN-P)	6b	0B	00	6b	0B	01	00, 01 (Off/On)	00	Off
	External Zone SWELL (EX-S)	6b	0C	00	6b	0C	01	00, 01 (Off/On)	00	Off
	External Zone GREAT (EX-G)	6b	0D	00	6b	0D	01	00, 01 (Off/On)	00	Off
External Zone PEDAL (EX-P)	6b	0E	00	6b	0E	01	00, 01 (Off/On)	00	Off	
MIDI	Transmit Internal Zone	-	-	00	6b	0F	01	00, 01 (Off/On)	01	On
	Transmit External Zone	-	-	00	6b	10	01	00, 01 (Off/On)	00	Off

Example "b" means Bank number
 Set Bank 2 Animation On via NRPN.....Bx 62 61 63 07 06 01 (x = SWELL channel)
 Set Bank 2 Animation On via System Exclusive.....F0 55 dd 10 1D 13 00 61 07 01 F7 (dd = Device ID)

Preset Parameters

Category	Parameter	NRPN		SysEx Address			SysEx Length	Data	Preset Load
		LSB (62)	MSB (63)	MSB to LSB					
SWELL Name	10 Characters	--	--	01	00	00	0A	7 bit ASCII	always
GREAT Name	10 Characters	--	--	01	00	01	0A	7 bit ASCII	always
Internal Zone SWELL	Pedal To Swell	30	00	00	30	00	01	00, 01 (Off/On)	IN-S
	P to S Range Hi	30	01	00	30	01	01	24 - 60 (MIDI note number)	
	SWELL Drb Octave Shift	30	02	00	30	02	01	3E - 40 - 42 (-2 - 0 - +2)	
	SWELL Drb Key Range Lo	30	03	00	30	03	01	24 - 60 (MIDI note number)	
	SWELL Drb Key Range Hi	30	04	00	30	04	01	24 - 60 (MIDI note number)	
	Glide Length	30	05	00	30	05	01	28 - 40 - 4C (-24 - 0 - +12 semitones)	
	Glide Time	30	06	00	30	06	01	00 - 31 (0.1 - 5.0 seconds)	
	Glide Amp	30	07	00	30	07	01	00, 01 (Off/On)	
Internal Zone GREAT	Pedal To Great	31	00	00	31	00	01	00, 01 (Off/On)	IN-G
	P to G Range Hi	31	01	00	31	01	01	24 - 60 (MIDI note number)	
	GREAT Drb Octave Shift	31	02	00	31	02	01	3E - 40 - 42 (-2 - 0 - +2)	
	GREAT Drb Key Range Lo	31	03	00	31	03	01	24 - 60 (MIDI note number)	
	GREAT Drb Key Range Hi	31	04	00	31	04	01	24 - 60 (MIDI note number)	IN-P
	Great To Pedal	32	00	00	32	00	01	00, 01 (Off/On)	
	G to P Range Hi	32	01	00	32	01	01	24 - 3C (MIDI note number)	
	PEDAL Drb Octave Shift	32	02	00	32	02	01	3E - 40 - 42 (-2 - 0 - +2)	
PEDAL Drb Key Range Lo	32	03	00	32	03	01	24 - 60 (MIDI note number)		
PEDAL Drb Key Range Hi	32	04	00	32	04	01	24 - 60 (MIDI note number)		
External Zone	MIDI Channel	4p	00	00	4p	00	01	00 - 10 (1 - 16, Off)	EX-S for SWELL (p=0) EX-G for GREAT (P=1) EX-P for PEDAL (p=2)
	Octave Shift	4p	01	00	4p	01	01	3E - 40 - 42 (-2 - 0 - +2)	
	Key Range Lo	4p	02	00	4p	02	01	24 - 60 (MIDI note number)	
	Key Range Hi	4p	03	00	4p	03	01	24 - 61 (MIDI note number)	
	Bank Select MSB	4p	04	00	4p	04	01	00 - 7F	
	Bank Select LSB	4p	05	00	4p	05	01	00 - 7F	
	Program Change	4p	06	00	4p	06	01	00 - 7F	
	Volume	4p	07	00	4p	07	01	00 - 7F	
	Pan	4p	08	00	4p	08	01	00 - 40 - 7F (L64 - C - R64)	
	Velocity	4p	09	00	4p	09	01	00 - 04 (Off, Normal - Easy)	
	Expression Minimum	4p	0A	00	4p	0A	01	00 - 3F (0 - 63)	
	Expression Maximum	4p	0B	00	4p	0B	01	40 - 7F (64 - 127)	
	Expression CC#	4p	0C	00	4p	0C	01	00, 01 (7, 11)	
	Percussion	Second On	08	00	00	08	00	01	
Third On		08	01	00	08	01	01	00, 01 (Off/On)	
Decay Fast		08	02	00	08	02	01	00, 01 (Off/On)	
Volume Soft		08	03	00	08	03	01	00, 01 (Off/On)	
Level On Soft		08	04	00	08	04	01	00 - 0F (1 - 16)	
Level On Normal		08	05	00	08	05	01	00 - 0F (1 - 16)	
Decay Fast		08	06	00	08	06	01	00 - 09 (1 - 9, Cont)	
Decay Slow		08	07	00	08	07	01	00 - 09 (1 - 9, Cont)	
Touch		08	08	00	08	08	01	00, 01 (Off/On)	
Velocity		08	09	00	08	09	01	00, 01 (Off/On)	
Key Track		08	0A	00	08	0A	01	00, 01 (Off/On)	
Drawbar 1' Cancel		08	0B	00	08	0B	01	00, 01 (Off/On)	
Drawbar Level		08	0C	00	08	0C	01	00, 01 (0, -3dB)	
SWELL & GREAT		Tone wheel Set	20	00	00	20	00	01	00 - 04 00: B-Type 1 01: B-Type 2 02: Mellow 03: Brite 04: Sawtooth
	Key Click Attack	20	01	00	20	01	01	00 - 0F (0 - 15)	
	Key Click Release	20	02	00	20	02	01	00 - 0F (0 - 15)	
	Fold Back Lo	20	05	00	20	05	01	00 - 0C (C1 - C2)	
	Fold Back Hi	20	06	00	20	06	01	2B - 30 (G4 - C5)	
	Key Click LPF	20	07	00	20	07	01	00 - 7F (0 - 127)	
	Custom TW B-Type 1	20	08	00	20	08	01	00 - 04 (1 - 5)	
	Custom TW B-Type 2	20	09	00	20	09	01	00 - 04 (1 - 5)	
	Custom TW Mellow	20	0A	00	20	0A	01	00 - 04 (1 - 5)	
	Custom TW Brite	20	0B	00	20	0B	01	00 - 04 (1 - 5)	
	Custom TW Sawtooth	20	0C	00	20	0C	01	00 - 04 (1 - 5)	

Category	Parameter	NRPN		SysEx Address			SysEx Length	Data	Preset Load
		LSB (62)	MSB (63)	MSB to LSB					
SWELL Draw-bars	16'	--	--	01	01	00	01	00 - 08 (0 - 8)	SWL
	5 1/3'	--	--	01	01	01	01	00 - 08 (0 - 8)	
	8'	--	--	01	01	02	01	00 - 08 (0 - 8)	
	4'	--	--	01	01	03	01	00 - 08 (0 - 8)	
	2 2/3'	--	--	01	01	04	01	00 - 08 (0 - 8)	
	2'	--	--	01	01	05	01	00 - 08 (0 - 8)	
	1 3/5'	--	--	01	01	06	01	00 - 08 (0 - 8)	
	1 1/3'	--	--	01	01	07	01	00 - 08 (0 - 8)	
1'	--	--	01	01	08	01	00 - 08 (0 - 8)		
GREAT Draw-bars	16	--	--	01	02	00	01	00 - 08 (0 - 8)	GRT
	5 1/3'	--	--	01	02	01	01	00 - 08 (0 - 8)	
	8'	--	--	01	02	02	01	00 - 08 (0 - 8)	
	4'	--	--	01	02	03	01	00 - 08 (0 - 8)	
	2 2/3'	--	--	01	02	04	01	00 - 08 (0 - 8)	
	2'	--	--	01	02	05	01	00 - 08 (0 - 8)	
	1 3/5'	--	--	01	02	06	01	00 - 08 (0 - 8)	
	1 1/3'	--	--	01	02	07	01	00 - 08 (0 - 8)	
1'	--	--	01	02	08	01	00 - 08 (0 - 8)		
PEDAL	Tone wheel Set	22	00	00	22	00	01	00 - 03 00: Normal 01: Muted 02: Synth 1 03: Synth 2	DRAWB PED
	Attack	22	01	00	22	01	01	00 - 04 00: Slow Attack 01: No Click 02: Soft Click 03: Normal Click 04: Max Click	
	Sustain On	22	02	00	22	02	01	00, 01 (O#/On)	
	Sustain Length	22	03	00	22	03	01	00 - 04 (1 - 5)	
	Decay Length	22	04	00	22	04	01	00 - 05 (1 - 5, Cont)	
	Key Mode	22	05	00	22	05	01	00, 01 (Mono/Poly)	
	Velocity	22	06	00	22	06	01	00 - 04 (Off, 1 - 4)	
PEDAL Draw-bars	16'	--	--	01	03	00	01	00 - 08 (0 - 8)	PED
	8'	--	--	01	03	01	01	00 - 08 (0 - 8)	
Animation	Leslie On	09	00	00	09	00	01	00, 01 (O#/On)	ANI for SWELL Preset
	Leslie Fast	09	01	00	09	01	01	00, 01 (O#/On)	
	Leslie Brake	09	02	00	09	02	01	00, 01 (O#/On)	
	Leslie Cabinet Number	09	03	00	09	03	01	00 - 07 (1 - 8)	
	Vibrato On SWELL	09	04	00	09	04	01	00, 01 (O#/On)	
	Vibrato Mode	09	05	00	09	05	01	00 - 05 (V1 - C3)	
	Vibrato Rate	09	06	00	09	06	01	00 - 04 (6.1 - 7.25 Hz)	
	Vibrato V1 Depth	09	07	00	09	07	01	00 - 0F (1 - 16)	
	Vibrato V2 Depth	09	08	00	09	08	01	00 - 0F (1 - 16)	
	Vibrato V3 Depth	09	09	00	09	09	01	00 - 0F (1 - 16)	
	Vibrato C1 Depth	09	0A	00	09	0A	01	00 - 0F (1 - 16)	
	Vibrato C2 Depth	09	0B	00	09	0B	01	00 - 0F (1 - 16)	
	Vibrato C3 Depth	09	0C	00	09	0C	01	00 - 0F (1 - 16)	
	Vibrato Tremolo	09	0D	00	09	0D	01	00 - 0F (0 - 15)	
	Vibrato Cho. Emphasis	09	0E	00	09	0E	01	00 - 09 (0 - 9)	
Vibrato On GREAT	21	00	00	21	00	01	00, 01 (O#/On)	ANI for GREAT Preset	
Overdrive	OD On	09	10	00	09	10	01	00, 01 (O#/On)	OD
	OD Drive Level	09	0F	00	09	0F	01	00 - 3F (0 - 63)	
	OD Exp. Control	09	11	00	09	11	01	00, 01 (O#/On)	

Example "p" means Zone number. SWELL=0, GREAT=1, PEDAL=2
 Turn Great to Pedal On via NRPN..... Bx 62 07 63 02 06 01 (x = SWELL channel)
 Turn Great to Pedal On via System Exclusive..... F0 55 dd 10 1D 13 00 07 02 01 F7 (dd = Device ID)

Category	Parameter	NRPN		SysEx Address			SysEx Length	Data	Preset Load
		LSB (62)	MSB (63)	MSB	MSB to LSB	LSB			
Equalizer, Reverb	EQ Bass Gain	0A	00	00	0A	00	01	00 - 09 - 12 (-9 - 0 - +9)	EQRV
	EQ Mid Gain	0A	01	00	0A	01	01	00 - 09 - 12 (-9 - 0 - +9)	
	EQ Treble Gain	0A	02	00	0A	02	01	00 - 09 - 12 (-9 - 0 - +9)	
	EQ Mid Frequency	0A	03	00	0A	03	01	00 - 0A (480 - 2.9 kHz)	
	EQ Tone Control	0A	04	00	0A	04	01	00 - 09 - 12 (-9 - 0 - +9)	
	Reverb On	0A	05	00	0A	05	01	00, 01 (Off/On)	
	Reverb Type	0A	06	00	0A	06	01	00 - 0A 00: Room 1 01: Room 2 02: Live House 03: Hall 1 04: Hall 2 05: Church 06: Plate 07: Spring 08: Delay 09: Panning Delay 0A: Reverb + Delay	
	Reverb Depth	0A	07	00	0A	07	01	00 - 0F (0 - 15)	
	Reverb Time	0A	08	00	0A	08	01	00 - 1F (0 - 31)	
	Reverb Delay Feedback	0A	09	00	0A	09	01	00 - 1F (0 - 96%)	
	Reverb Delay Time	0A	0A	00	0A	0A	01	00 - 44 (4.7 - 2000 ms)	
	Leslie On Reverb	0A	0B	00	0A	0B	01	00,01 (Off/On)	

Leslie Parameters

Category	Parameter	NRPN (OR)		NRPN (21)		SysEx Address			SysEx Length	Data
		LSB (62)	MSB (63)	LSB (62)	MSB (63)	MSB	MSB to LSB	LSB		
Cabinet	Name	--	--	--	--	03	00	00	0A	(10 Characters)
	Slow Speed Horn	06	00	7F	00	00	06	00	01	
	Slow Speed Bass	06	01	7F	01	00	06	01	01	
	Fast Speed Horn	06	02	7F	02	00	06	02	01	
	Fast Speed Bass	06	03	7F	03	00	06	03	01	
	Rise Time Horn	06	04	7F	04	00	06	04	01	
	Rise Time Bass	06	05	7F	05	00	06	05	01	
	Fall Time Horn	06	06	7F	06	00	06	06	01	
	Fall Time Bass	06	07	7F	07	00	06	07	01	
	Brake Time Horn	06	08	7F	08	00	06	08	01	
	Brake Time Bass	06	09	7F	09	00	06	09	01	
	Level Horn	06	0A	--	--	00	06	0A	01	
	Level Bass	06	0B	--	--	00	06	0B	01	
	Mic. Angle	06	0C	7F	0A	00	06	0C	01	
	Mic. Distance	06	0D	7F	0B	00	06	0D	01	
	Horn Character	06	0E	7F	0D	00	06	0E	01	
	Amplifier	06	0F	--	--	00	06	0F	01	
Speaker	06	10	--	--	00	06	10	01		

System Parameters

Category	Parameter	Data Range	Default
MIDI	Local	Off / On	On
	TRx. NRPN	Off / On	On
	Tx. Leslie Param.	OR / 21	OR
	TRx. Prog. Change	Off / On	On
	TRx. Drawbar Regl.	Off / On	On
	TRx. Channel SWELL	1 - 16, Off	1
	TRx. Channel GREAT	1 - 16, Off	2
	TRx. Channel PEDAL	1 - 16, Off	3
	Tx. Channel Leslie	1 - 16, Off	1
	Rx. Dump	Off / On	On
	Device ID	1 - 32	1
Display	To Shortcut	0, 1, 2 sec, No	1 sec
	Time Out	4, 8, 6 sec, No	No
Ext. Leslie	Channel	1, 2 or 3	1

MIDI IMPLEMENTATION CHART

Chapel Console Organ
Model: A-162

MIDI Implementation Chart

Date: 16-Apr-2013
Version: 1.0

Function		Transmitted	Recognized	Remarks
Basic Channel	Default Changed	*1 1 - 16	*1 1 - 16	*1: SWELL = 1, GREAT = 2, PEDAL = 3
Mode	Default Messages Altered	3 X *****	3 X X	
Note Number	: True Voice	12 - 120 *****	36 - 96 36 - 96	
Velocity	Note ON Note OFF	O X	O X	for percussion, EXZ
After Touch	Key's Ch's	X X	X X	
Pitch Bend		X	X	
Control Change	0, 32	O	O	Bank Select MSB, LSB
	6, 38	O	O	Data Entry MSB, LSB
	7	O	X	Volume
	10	O	X	Pan
	11	O	O	Expression
	12 - 20	O	O	Drawbar Reg. SWELL
	21 - 29	O	O	Drawbar Reg. GREAT
	33, 35	O	O	Drawbar Reg. PEDAL
	48	O	O	Spring Shock
	64	O	O	Damper
98, 99	O	O	NRPN MSB, LSB	
Program Change	: True #	O 0 - 127	O 0 - 11	
System Exclusive		O	O	
System Common	: Song Position : Song Select : Tune	X X X	X X X	
System Real Time	: Clock : Commands	X X	X X	
Aux Messages	: All Sounds Off : Reset All Controllers : Local On/Off : All Notes Off : Active Sense : Reset	X O X O O X	O O X O O X	(120) (121)

Mode 1: OMNI ON, POLY Mode 2: OMNI ON, MONO
Mode 3: OMNI OFF, POLY Mode 4: OMNI OFF, MONO

O: Yes
X: No

FACTORY PRESETS

◆ Bank C "Jazz 1"

Key	C	C#	D	D#	E	F	F#	G	G#	A	A#
SWELL	Cancel	Jimmy	Lo & Hi 1	Warmth	Groove	Funky	Purple	Funky 2	Full Tibias	Full Organ	Full Church
GREAT	Cancel	Jimmy	Lo & Hi 1	Warmth	Groove	Funky	Purple	Funky 2	Full Tibias	Full Organ	Full Church

◆ Bank C# "Jazz 2"

Key	C	C#	D	D#	E	F	F#	G	G#	A	A#
SWELL	Cancel	Jimmy 1	Jimmy 2	Jimmy 3	Burner	Groove	Smooth Bass	Shirley	Jimmy MC	Fat Bass	All Nine
GREAT	Cancel	Jimmy 1	Jimmy 2	Jimmy 3	Burner	Groove	Smooth Bass	Shirley	Jimmy MC	Fat Bass	All Nine

◆ Bank D "Gospel 1"

Key	C	C#	D	D#	E	F	F#	G	G#	A	A#
SWELL	Cancel	Gospel 1	Gospel 2	Gospel 3	Gospel 4	Praise 1	Praise 2	Praise 3	Praise 4	Meditation	UM Bass
GREAT	Cancel	Gospel 1	Gospel 2	Gospel 3	Gospel 4	Praise 1	Praise 2	Praise 3	Praise 4	Meditation	Full Gospel

Gospel 1: Used often for up-tempo Gospel songs such as "O Give Thanks."

Gospel 2: A melody registration, usually played using a single-note melody ("I Need Thee Every Hour," "Great Is Thy Faithfulness," etc.)

Gospel 3: Can be used either for up-tempo songs ("I'm So Glad Jesus Lifted Me," etc.) or slower songs ("The Blood That Jesus Shed For Me," "He Touched Me," etc.).

Gospel 4: A "lo - hi" registration that can be used for more anthem-like songs such as "Thank You Lord."

Praise 1: Useful for louder or more up-tempo songs ("This Is The Day," "I Have The Victory," etc.)

Praise 2: A mellower setting for slower songs ("Lord You Are Welcome In This Place," "Lord Prepare Me To Be A Sanctuary," etc.)

Praise 3: An 8' registration useful for single note melodies on slower songs.

Praise 4: A loud registration useful for a final chorus on a song like "O Come, Let Us Adore Him," which starts out soft and gradually builds.

◆ Bank D# "Gospel 2"

Key	C	C#	D	D#	E	F	F#	G	G#	A	A#
SWELL	Cancel	Perc 2nd	Perc 3rd L	Lo&Hi EarL	Lo&Hi Chors	Perc 1	Perc 2	Perc 3	Full 1	Full 2	Full 3
GREAT	Cancel	LM Bass	Full Brite	Soft Accomp	LM Chorus	Accomp 1	Accomp 2	Accomp 3	Full 1	Full 2	Full 3

◆ Bank E "Theatre"

Key	C	C#	D	D#	E	F	F#	G	G#	A	A#
SWELL	Cancel	Theatre 1	Theatre 2	Theatre 3	Theatre 4	Theatre 5	Theatre 6	Theatre 7	Theatre 8	Theatre 9	Full Theatre
GREAT	Cancel	Theatre 1	Theatre 2	Theatre 3	Theatre 4	Theatre 5	Theatre 6	Theatre 7	Theatre 8	Theatre 9	Full Theatre

Theatre 1: Tibias 16' and 2 plus Vox

Theatre 2: Tibias 16', 4' and 2 2/3' plus Vox

Theatre 3: Tibias 16', 8' & 2'

Theatre 4: Tibias 16' & 4'

Theatre 5: Tibias 16', 8' & 4' plus Strings & Vox

Theatre 6: Strings 16' & 8' plus Tibias 4' & 2'. Use mostly for chorded melody.

Theatre 7: Tibia & Vox 16'

Theatre 8: Harmonic Tuba

Theatre 9: Full ensemble plus Xylophone

Full Thtre: Tibias plus Strings, Vox & ensemble Reeds.

◆ Bank F "Tibia"

Key	C	C#	D	D#	E	F	F#	G	G#	A	A#
SWELL	Cancel	Tibia 8&4	Tibia 8&2	Tibia&Vox	Tibia 8 4&2	Tibia 16&8	Tibia 16&4	Tibia 16 8&4	Tibia 16 8 4 2	Tba 16 8 4 2 1	Full Tibia
GREAT	Cancel	Tibia 8&4	Tibia 8&2	Tibia&Vox	Tibia 8 4&2	Tibia 16&8	Tibia 16&4	Tibia 16 8&4	Tibia 16 8 4 2	Tba 16 8 4 2 1	Full Tibia

◆ Bank F# "Church Organ"

Key	C	C#	D	D#	E	F	F#	G	G#	A	A#
SWELL	Cancel	Gedeckr 8	Flute 8&4	Principal 8	Chors&Mixt	Rohr Flute	Gamba Clst	Cornet	Sesquialtr	Chors&Mixt	Sforzando
GREAT	Cancel	Stopped Diap	Flute 8&4	Montre 8	Princpl Chors	Flute 8 4 11/3	Flute Celeste	Echo Diapsn	French Horn	Trompette	Sforzando

◆ Bank G "Pop Organ"

Key	C	C#	D	D#	E	F	F#	G	G#	A	A#
SWELL	Cancel	Lo & Hi 1	Lo & Hi 2	Lo & Hi 3	Odd Harm	Chorus	Perc 16 & 4	Solo 16 & 2	Cute Solo	Lenny	Full Hamm
GREAT	Cancel	Lo & Hi 1	Lo & Hi 2	Lo & Hi 3	Odd Harm	Chorus	Perc 16 & 4	Solo 16 & 2	Cute Solo	Lenny	Full Hamm

◆ **Bank G# "User Presets"**

Key	C	C#	D	D#	E	F	F#	G	G#	A	A#
SWELL	Cancel	User 1	User 2	User 3	User 4	User 5	User 6	User 7	User 8	User 9	User 10
GREAT	Cancel	User 1	User 2	User 3	User 4	User 5	User 6	User 7	User 8	User 9	User 10

All the Presets in this Bank are blank for non-distractive edit.

◆ **Bank A "MIDI Presets"**

Key	C	C#	D	D#	E	F	F#	G	G#	A	A#
SWELL	Cancel	Grand Piano	Vibes	Flute	Violin	French Horn	Church Organ	Brass Choir	Ovdr Guitar	Soprano Sax	Strgs&Orgn
GREAT	Cancel	Strings	Jazz Guitar	Nylon Guitar	Harp	Pizzicato Str	Chimes	Brite Piano	Dist Guitar	New Age Pad	Choir&Orgn

This bank desired use with GM Level 1 sound module.

◆ **Bank A# "Hammond Theatre Presets"**

Key	C	C#	D	D#	E	F	F#	G	G#	A	A#
SWELL	Cancel	Theatre C#	Theatre D	Theatre D#	Theatre E	Theatre F	Theatre F#	Theatre G	Theatre G#	Theatre A	Theatre A#
GREAT	Cancel	Theatre C#	Theatre D	Theatre D#	Theatre E	Theatre F	Theatre F#	Theatre G	Theatre G#	Theatre A	Theatre A#

◆ **Bank B "Hammond Liturgical Presets"**

Key	C	C#	D	D#	E	F	F#	G	G#	A	A#
SWELL	Cancel	Stopped Fl	Dulciana	Fr. Horn	Salicional	Flutes 8&4	Oboe Horn	Diapason	Trumpet	Full Swell	Full Litur
GREAT	Cancel	Cello	Flute & Strg	Clarinet	DiapGmbFlt	Great NoRd	Open Diap	Full Great	Tibia Claus	Full Grt & 16	Full Litur

DEMONSTRATION SONGS

1. Amazing Grace
 2. Blessed Assurance
 3. What A Fellowship
 4. The Church's One Foundation
 5. Is Your All On The Altar
 6. Abide With Me
 7. Great Is Thy Faithfulness
- performed by Steven Eaklor

Sound Generator**Drawbars**

2 - VASE III as Digital tone wheels, 61 - note polyphony

Keyboards

SWELL: 73 (C1 to C6 61-key + 12 Preset Keys)

GREAT: 73 (C1 to C6 61-key + 12 Preset Keys)

PEDAL: 25-note radiating, detachable

Harmonic Drawbars**Drawbars**

SWELL: 9 Pitches

GREAT: 9 Pitches

PEDAL: 2 Pitches

Voicing

Manuals: 5 choices (B-Type1, B-Type2, Mellow, Brite, Sawtooth), variable key-click

PEDAL: 4 choices (Normal, Muted, Synth1, Synth2), 5 choices key-click

Touch Response Percussion**Buttons**

Second, Third, Fast, Soft

Adjustable

Touch, Velocity, Decay (Fast, Slow), Level (Normal, Soft)

Effects**Internal Leslie**

Advanced Digital, 2 Rotors

Buttons: Brake, On, Fast

Vibrato and Chorus

Digital Scanner

Rotary Mode Knob: V1, V2, V3, C1, C2, C3

Buttons: SWELL On, GREAT On

Overdrive

Digital

Equalizer

Bass, Mid (sweep), Treble, Tone

Reverb

Digital, 11 programs

Sustain

PEDAL Drawbars

Tuning**Master**

430 - 450, 1 Hz Steps

Transpose

-6 to +6 semitones

Coupler**Functions**

Pedal to Great, Great to Pedal, Pedal to Swell

Adjustable

Highest note

Presets**Capacity**

12 Banks, 11 Presets per manual ("C" key can be used as a Preset)

Preset Load Option

Drawbar Registration, Drawbar Parameters, Percussion, Internal Zone, External Zone, EQ/Reverb, Animation, Overdrive

Controllers**Volumes**

Master Volume, External Leslie Volume

Pedal

Expression Pedal w/1 - Foot Switch

Storage

CompactFlash Card Slot

Display

20 - Characters, 2 - Lines

9 Control Buttons, Value Knob

MIDI**Templates**

3 Templates

Internal Zones

1 Zone per keyboard

External Zones

1 Zone per keyboard

Connections**MIDI**

In, Out

Audio

Line In L, R, Microphone In w/Volume control,

Line Out L, R, Headphones

Leslie

11 - pin, 1 to 3 channels available

Other

Foot Switch (optional CU-1 console switch)

Sound System**Amplification**

3 - 50 watt RMS amplifier

Speakers

8" and 6" Full Range, 15" Woofer

Dimensions

without rack and Pedalboard

38"(H), 47"(W), 25½"(D)

with rack and Pedalboard

45"(H), 47"(W), 36½"(D)

Weight

Console 200 lbs

Pedalboard 76 lbs

Bench 42 lbs

Hammond maintains a policy of continuously improving and upgrading its instruments and therefore reserves the right to change specifications without notice. Although every attempt has been made to insure the accuracy of the descriptive contents of this Manual, total accuracy cannot be guaranteed.

Should the owner require further assistance, inquiries should first be made to your Authorized Hammond Dealer. If you still need further assistance, contact Hammond at the following addresses:

In the United States Contact:

HAMMOND SUZUKI USA, Inc.
743 Annoreno Dr.
Addison, IL 60101
UNITED STATES

Web site: www.hammondoraganco.com

In Europe contact:

HAMMOND SUZUKI EUROPE B. V.
I.R. D. S. Tuynmanweg 4A
4131 PN Vianen
THE NETHERLANDS

E-mail: info@hammondsuzuki.com
Web site: www.hammond.eu

All other countries contact:

HAMMOND SUZUKI Ltd.
25-11, Ryoke 2 Chome,
Naka-ku, Hamamatsu
430-0852 (Shizuoka)
JAPAN

Web site: www.suzuki-music.co.jp

Technical materials are available and can be obtained by mailing a request to the appropriate address listed above marked ATTENTION: SERVICE DEPARTMENT.

Manufacturer:
SUZUKI MUSICAL INSTRUMENT MFG. Co., Ltd.
25-12, Ryoke 2 Chome, Naka-ku,
Hamamatsu 430-0852 (Shizuoka)
JAPAN

