

Innovative Sound Systems

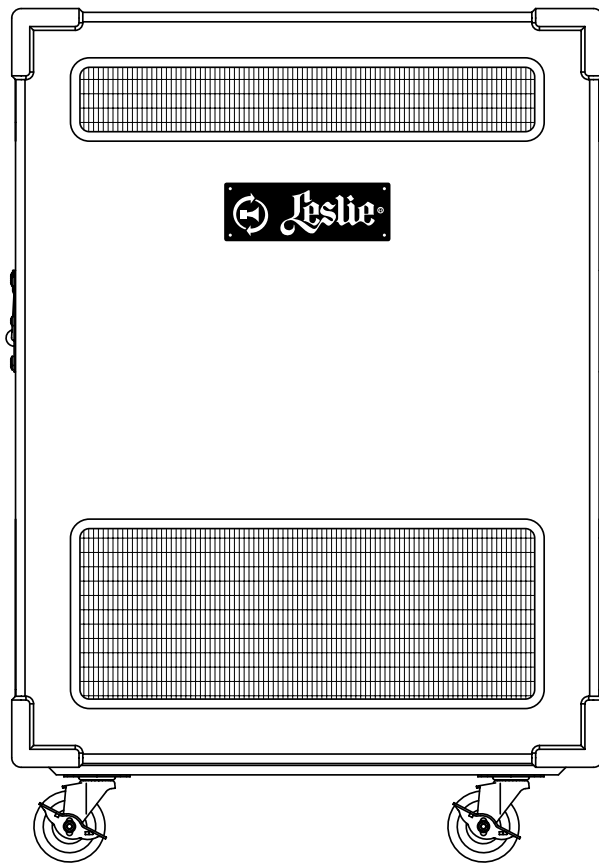

Model 3300

Owner's Manual

Read these instructions.

Keep these instructions.

Heed all warnings.

Follow all instructions.

Do not use this apparatus near water.

Clean only with dry cloth.

Do not block any ventilation openings.

Install in accordance with the manufacturer's instructions.

Do not install near any heat sources such as radiators, heat registers, stoves or other apparatus (including amplifiers) that produce heat.

Do not defeat the safety purpose of the polarized or grounding-type plug. A polarized plug has two blades with one wider than the other. A grounding type plug has two blades and a third grounding prong. The wider blade or third prong is provided for your safety. If the provided plug does not fit into your outlet, consult an electrician for replacement of the obsolete outlet.

Protect the power cord from being walked on or pinched, particularly at plugs, convenience receptacles, and the point where they exit from the apparatus.

Only use attachments/accessories specified by the manufacturer.

Use only with the cart, stand, tripod, bracket, or table specified by the manufacturer, or sold with the apparatus. When cart is used: use caution when moving the cart/apparatus combination to avoid injury from tip-over.

PORTABLE CART WARNING



S3125A

Unplug this apparatus during lightning storms, or when unused for long periods of time.

Refer all servicing to qualified service personnel. Servicing is required when the apparatus has been damaged in any way, such as power-supply cord or plug is damaged, liquid has been spilled or objects have fallen into the apparatus, the apparatus has been exposed to rain or moisture, does not operate normally, or has been dropped.

Apparatus shall not be exposed to dripping or splashing and no objects filled with liquids, such as vases, shall be placed on the apparatus.

WARNING: To reduce the risk of fire or electric shock, do not expose this apparatus to rain or moisture.

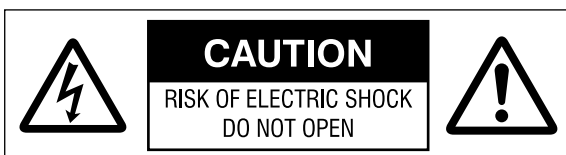

注意：感電の恐れありキャビネットをあけるな

ATTENTION: RISQUE DE CHOC ELECTRIQUE NE PAS OUVRI

WARNING:

TO REDUCE THE RISK OF FIRE OR ELECTRIC SHOCK,
DO NOT EXPOSE THIS APPLIANCE TO RAIN OR MOISTURE.

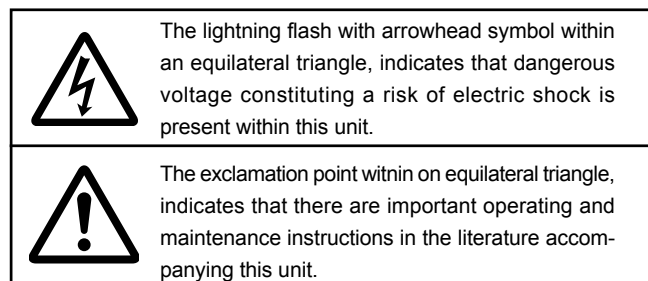

In case in the future your instrument gets too old to play/use or malfunctions beyond repair, please observe the instructions of this mark, or, if any question, be sure to contact your dealer or your nearest town or municipal office for its proper disposal.



FOR UNITED KINGDOM:

FOR YOUR SAFETY, PLEASE READ THE FOLLOWING TEXT CAREFULLY

This appliance is supplied with a molded 3-pin mains plug for your safety and convenience.

The plug contains a 5 amp fuse.

Should the fuse need to be replaced, please ensure that the replacement fuse has a rating of 5 amps and that it is approved by ASTA or BSI to BSI1362.

Check for the ASTA mark  or the BSI mark  on the body of the fuse.

If the plug contains a removable fuse cover, you must ensure that it is refitted when the fuse is replaced.

If the fuse cover is lost, the plug must not be used until a replacement cover is obtained.

A replacement fuse cover can be obtained from your local Hammond Dealer.

IF THE FITTED MOULDED PLUG IS UNSUITABLE FOR THE SOCKET OUTLET IN YOUR HOME, THEN THE FUSE SHOULD BE REMOVED AND THE PLUG CUT OFF AND DISPOSED OF SAFELY. THERE IS A DANGER OF SEVERE ELECTRICAL SHOCK IF THE CUT-OFF PLUG IS INSERTED INTO ANY 13 AMP SOCKET.

If a new plug is to be attached to the cord, please observe the wiring code as shown below.

If in any doubt, please consult a qualified electrician.

IMPORTANT - The wires in this mains lead are coloured in accordance with the following code:

Blue:	Neutral
Brown:	Live

As the colours of the wires in the mains lead of this unit may not correspond with the coloured marking identifying the terminals in your plug, proceed as follows.

The wire which is coloured BLUE must be connected to the terminal in the plug which is marked with the letter N or coloured BLACK.

The wire which is coloured BROWN must be connected to the terminal in the plug which is marked with the letter L or coloured RED.

Under no circumstances should either of these wires be connected to the earth terminal of the three-pin plug, marked with the letter E or the Earth Symbol .

To replace the fuse, open the fuse compartment with a screwdriver and replace the fuse and fuse cover.

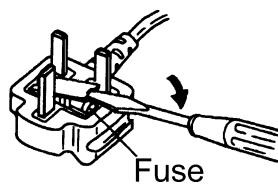

THANK YOU!

We greatly appreciate your purchase of a new Leslie speaker system. If this is your first purchase of a Leslie product, we would like to welcome you into the Leslie family. If you are a repeat customer, thank you for your continued confidence in our Leslie products.

Your new Leslie speaker system was engineered and manufactured to the most stringent-quality standards, reproducing the full-spectrum sound of musical instruments and housed in acoustically-engineered cabinet. This will assure that your new Leslie will sound and look great for many years to come. Your Leslie speaker culminates many years of research and dedication to the art of sound reproduction and is carefully designed and tested to provide long dependable service.

Many features have been included in this speaker to insure the finest sound from your organ or keyboard product. Please take a moment to carefully read this manual and familiarize yourself with many of the fine features found in your new Leslie speaker system. Take pride in being the owner of the most innovative sound system in the industry today.

MAIN FEATURES

- ◆ Even though the Leslie 3300 is packaged in a more compact cabinet than our traditional leslie speakers, it still produces a powerful dynamic sound. This unit contains a 300W High Power amplifier (Bass 220W, Horn 80W). A massive 38 cm woofer reproduces the deep bass sounds and our world famous 100W Ferro Fluid Horn driver reproduces the higher frequencies.
- ◆ The Leslie 3300 is equipped with a Tube Pre-amp that creates the warm Tube Sounds that many musicians desire. On previous Leslie speakers, sending excessively large signals to overdrive the power amplifiers and speakers created distortion sounds. By this method you could achieve your desired distortion sounds but only at a very high volume and with the risk of damaging the speaker or the horn-driver. The Leslie 3300 has the ability to produce the distortion sounds at any volume level. By simply adjusting the setting of the Tube Drive Level and Tube Mode controls, a wide range of distortion effects are produced from soft distortion to heavy metal distortion. If you desire, you can turn Off the Tube amplification and switch to the clean solid-state sounds.
- ◆ This unit is equipped with three different types of Input connectors. An 8-pin Input connector is provided for easy hookup to our XK-1 keyboard and XM-2, but also for older instruments like XB-1 and XM-1, and 11-pin Leslie connector is used to connect to newer Hammond organs, and a Line Input jack can be used to connect to most keyboard products on the market today.
- ◆ The Leslie 3300 contains Brushless DC Servo motors that are not affected by power frequency variations or voltage changes. These motors give you the ability to adjust the rise, fall, and the rotation speed of the rotors.

TYPE

1-channel (Rotary Channel Only)
Real 2-Rotor

POWER OUTPUT

Horn Rotor
80Wrms

Drum Rotor
220Wrms
(total power 300Wrms)

SPEAKER

Rotary Horn Driver
Ferro-Fluid

Woofer
Massive 15" (38cm) Woofer

OVERDRIVE

Vacuum Tube 12AX7 x 1
Tube Drive Level, Tube On/Off, Tube Mode

CONTROL

EQ: Bass (100Hz ±10dB), Middle (1.7kHz ±10dB),
Treble (8kHz ±10dB)
Volume, Horn Level, Sub Woofer Volume

MOTOR

Brushless DC Servo Motor x 2

ROTOR ADJUST

Horn:
Rise Time, Fall Time, Slow Speed, Fast Speed

Drum:
Rise Time, Fall Time, Slow Speed, Fast Speed

LED

Fast, Slow, Stop

CONNECTORS

Leslie 11-Pin Socket with Stationary L,R through Output,
Leslie 8-Pin,
Line Input 1/4", impd. 10kΩ sensitivity 100mV (-18dBu),
Line Out / Sub Woofer Out 0dBu,
Foot Switch (Slow/Fast/Stop)
AC Input

POWER CONSUMPTION

210W

DIMENSION

63(W) x 52(D) x 90(H) cm
24.8(W) x 20.5(D) x 35.4(H) inch

WEIGHT

57kg
125.7lbs

OPTIONAL

Leslie Cable 11-Pin
Leslie Cable 8-Pin (LC8-7M)
Foot Switch FS-9H

BLOCK DIAGRAM

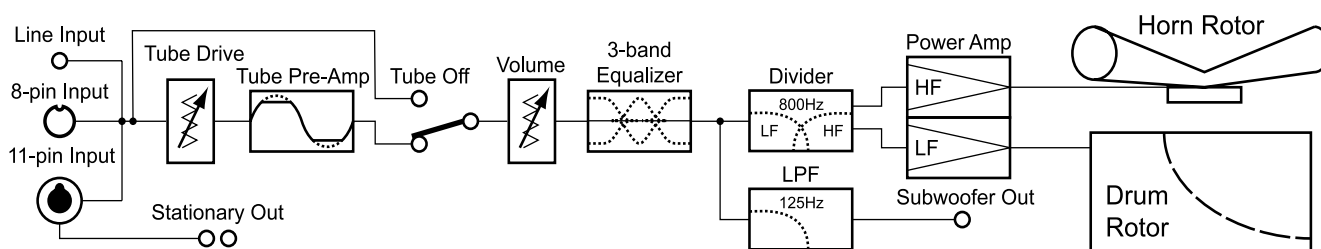

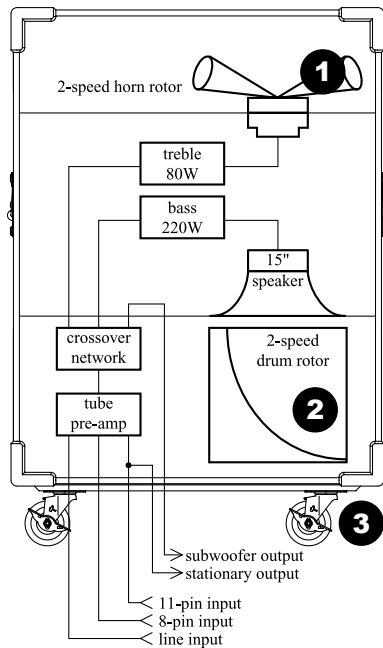

◆ FRONT

1. Horn Rotor (built-in)

This rotor reproduces the treble sounds.

2. Drum Rotor (built-in)

This rotor reproduces the bass sounds.

3. Casters

The casters located on the front of this Leslie should be locked during a performance and unlocked when transporting the Leslie.

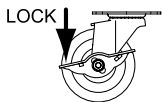

◆ POWER PANEL

4. POWER Switch

This switch is used for switching ON/OFF the power on the Leslie 3300. When you want to automatically switch ON/OFF the power on the Leslie 3300 by means of the equipment plugged into the Leslie's 11-pin connector, set the Power switch on the 3300 to the OFF(REMOTE) position.

5. AC Inlet

This connector is used to connect the AC Power Cable.

6. 11-PIN INPUT Socket

This socket is used to connect other organ and keyboard products that are equipped with an 11-pin Leslie connector.

7. STATIONARY OUT L (MAIN) Jack

8. STATIONARY OUT R (SUB) Jack

This jack outputs the sounds of the stationary channel of the organ or keyboard product that is plugged into the 11-pin Leslie connector (6). The stationary jack (7) outputs the sound of the Left (Main) channel while the stationary jack (8) outputs the Right (Sub) channel.

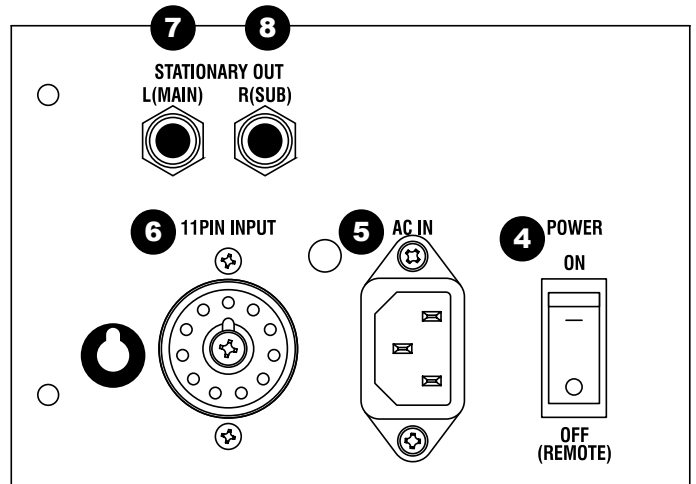

◆ CONTROL PANEL

9. LINE INPUT Jack

The Line Input jack is used for organs and keyboard products that are not equipped with a 11-pin Leslie connector or an 8-pin Leslie jack.

10. TUBE DRIVE LEVEL Control

This knob controls the level sent to the Tube Pre-amp. If you turn this control clockwise, the amount of distortion increases. If you fully turn this control counter-clockwise, the Tube Pre-amp circuit is bypassed.

11. VOLUME Control

This knob controls the total volume of this unit.

12. TUBE MODE Control

This controls the characteristics of the Tube Pre-Amp. If you turn this control clockwise, the Tube Gain increases, thus the amount of distortion increases.

13. BASS Control

This control boosts/cuts Bass.

14. MIDDLE Control

This control boosts/cuts Middle.

15. TREBLE Control

This control boosts/cuts Treble.

16. HORN LEVEL Control

This controls the volume of the Horn Rotor.

17. SUB WOOFER VOLUME Control

This controls the output level of the SUB WOOFER LINE OUT jack (18).

18. SUB WOOFER LINE OUT Jack

This jack is used to drive an external Powered Sub Woofer. The [Tip] of this jack outputs only Bass of 125Hz or lower, and the [Ring] outputs the whole range.

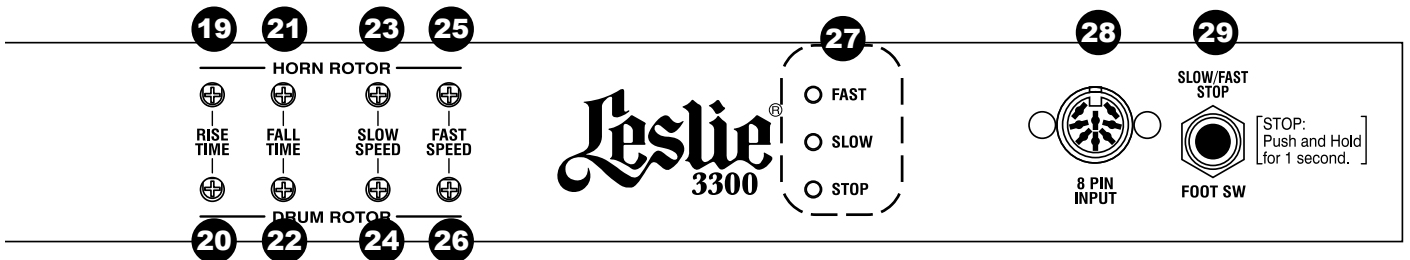
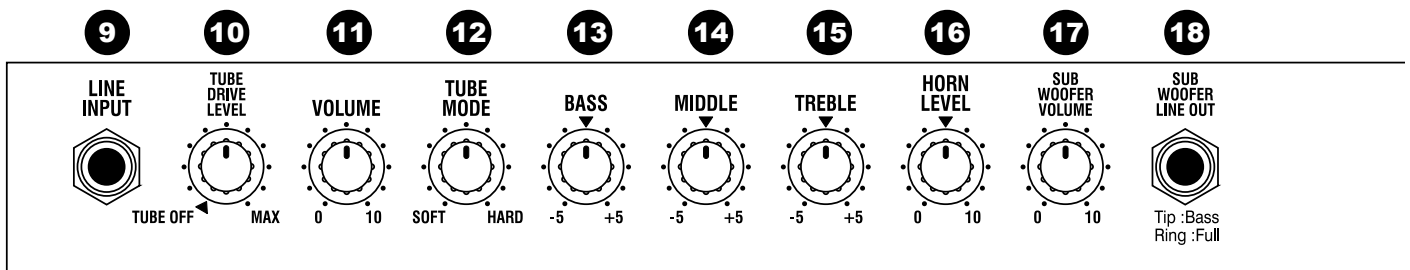

◆ TRIMMERS

The Trimmers controls are used to fine adjustments of the turning characteristics of each rotor. Use a flat blade screwdriver with the width of 2.5 to 3 mm to make these adjustments.

19. HORN ROTOR RISE TIME Trimmer

20. DRUM ROTOR RISE TIME Trimmer

This control changes the amount of time it takes to switch from Slow speed to Fast speed or Stop to Fast speed. If you turn trimmer clockwise, the time gets longer. Trimmer (19) adjusts the Horn Rotor and Trimmer (20) adjusts the Drum Rotor.

21. HORN ROTOR FALL TIME Trimmer

22. DRUM ROTOR FALL TIME Trimmer

This control changes the amount of time it takes to switch from Fast speed to Slow speed or Fast speed to Stop. If you turn this trimmer clockwise, the time gets longer. Trimmer (21) adjusts the Horn Rotor and Trimmer (22) adjusts the Drum Rotor.

23. HORN ROTOR SLOW SPEED Trimmer

24. DRUM ROTOR SLOW SPEED Trimmer

This Trimmer controls the speed of rotation of the rotor when it is in the Slow speed. Trimmer (23) adjusts the Horn Rotor and Trimmer (24) adjusts the Drum Rotor.

25. HORN ROTOR FAST SPEED Trimmer

26. DRUM ROTOR FAST SPEED Trimmer

This Trimmer controls the speed of rotation of the rotor when it is in the Fast speed. Trimmer (25) adjusts the Horn Rotor and Trimmer (26) adjusts the Drum Rotor.



- Examples -

◆ INDICATOR and JACKS

27. ROTOR MODE Indicator

These LED's indicates the current mode of the Rotor. Usually one of FAST, SLOW, or STOP LED's lights up when the power is ON.

28. 8-PIN INPUT Jack

This jack is used to connect organs and keyboards that are equipped with the 8-pin Leslie connector. Please note that the Stationary sounds that are imputed to this jack are not sent out of the Stationary Output jacks (7 & 8).

29. FOOT SW Jack

This jack is used in conjunction with the optional FS-9H Foot Switch, to control various modes of this unit. If you momentarily touch the pedal, it stiches from Slow to Fast speeds. if you hold the pedal down for 1.5 seconds or more, the rotors will stop rotating (stop).

⊘ Important Notice

Leslie speaker [VOLUME] control should be set to prevent distortion or overdriving speakers. Excessive input may cause serious damage to the Leslie and void your warranty. In order to make it easier for you to identify if the sound is being distorted by the speakers or the Leslie's [TUBE DRIVE] circuitry, we highly recommend that you set the Leslie's [VOLUME] with the [TUBE DRIVE] control to the "TUBE OFF" position.

8 HOOK-UP AND LESLIE SETUP PROCEDURES

◆ SINGLE CHANNEL HOOK-UP WITH AN 11-PIN LESLIE SOCKET

Applicable HAMMOND Models: New B-3, New C-3, B-3P, B-3M (Ultimo), XK-3 (NOTE 1), XK-2, XB-2, XB-5

NOTE 1: The default setting of the XK-3 is for 1 channel.

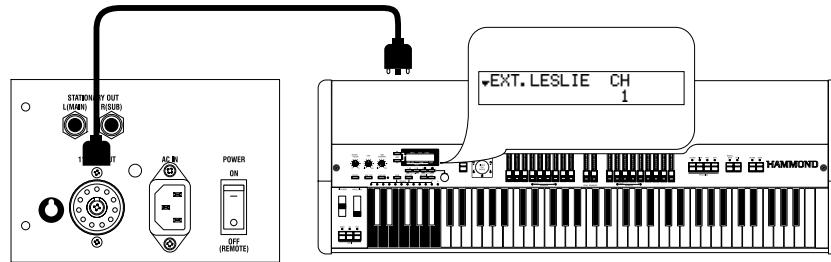

Steps:

1. Switch OFF the Power of the Organ.
2. Switch OFF (REMOTE) of the Power on the Leslie 3300.
3. Connect the optional 11-pin Leslie cable as shown above.
4. Set the VOLUME control on the Leslie to the 3 position, and turn the TUBE DRIVE LEVEL to the fully counterclockwise position (TUBE OFF).
5. Switch ON the Power on the Organ. The Leslie 3300 will automatically turn ON after a few moments and the Rotor Modo Indicator will light.
6. Switch the Leslie speed switch on the organ from Slow to Fast. The rotors in the Leslie 3300 should simultaneously change speeds from Slow to Fast and the Rotor Mode Indicator lights should switch from Slow to Fast.
7. While playing the organ at maximum volume, adjust the Volume setting on the Leslie for the desired volume level.

◆ THREE CHANNEL HOOK-UP WITH AN 11-PIN LESLIE SOCKET

Applicable HAMMOND Models: XE-1, XT-100, XH-200, XB-3, XC-3, XB-3M, XC-3M, 926, 935, XK-3 (NOTE 2)

NOTE 2: The XK-3 default setting must be changed from "1" to "2 or 3" channels.

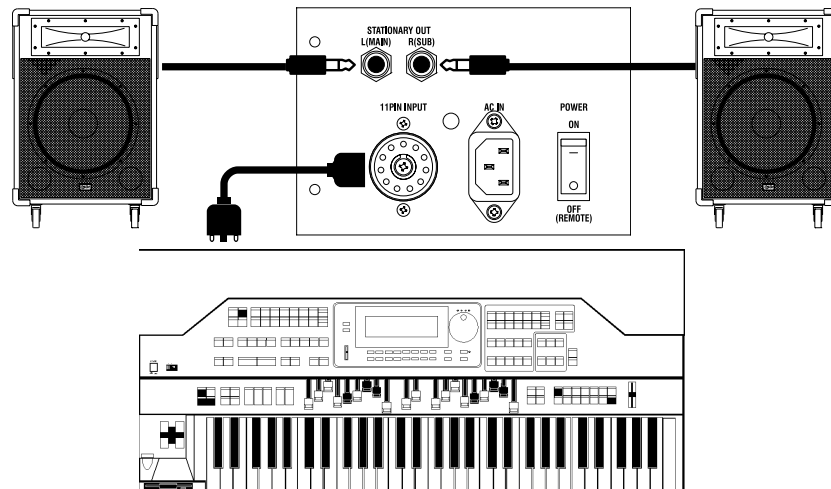

Steps:

1. Switch OFF the Power of the Organ.
2. Switch OFF (REMOTE) the Power on the Leslie 3300.
3. Connect the optional 11-pin Leslie cable as shown above.
4. Connect the Powered Speakers (Leslie 2121 is recommendable) to the STATIONARY OUT L, & R jacks as shown above.
5. Set the VOLUME control on the Leslie to the 3 position, and turn the TUBE DRIVE LEVEL to the fully counterclockwise position (TUBE OFF). Set the VOLUME control on the Powered Speaker to a suitable listening level.
6. Switch ON the Power on the Organ. The Leslie 3300 will automatically turn ON after a few moments and the Rotor Mode Indicator will light. Switch ON the Power to the Powered Speaker (2121).
7. Switch the Leslie speed switch on the organ from Slow to Fast. The rotors in the Leslie 3300 should simultaneously lights should switch from Slow to Fast.
8. Switch the Leslie ON/OFF switch on the organ to the ON position and select a Drawbar voice. While the Organ is being played at its maximum Volume, adjust the VOLUME control on the Leslie to your desired setting.
9. If your organ has a Leslie Brake Switch, turn it OFF. While playing a Drawbar sound on the organ, turn OFF the Leslie ON/OFF Switch so that the drawbar sounds are sent out to the Stationary Powered Speakers.
10. Adjust the VOLUME on the Powered Speakers so that the volume is balanced between the Stationary Powered Speakers and the Leslie.

◆ SINGLE CHANNEL HOOK-UP WITH AN 8-PIN LESLIE JACK

Applicable HAMMOND Models: XB-1, XK-1, XM-1, XM-2

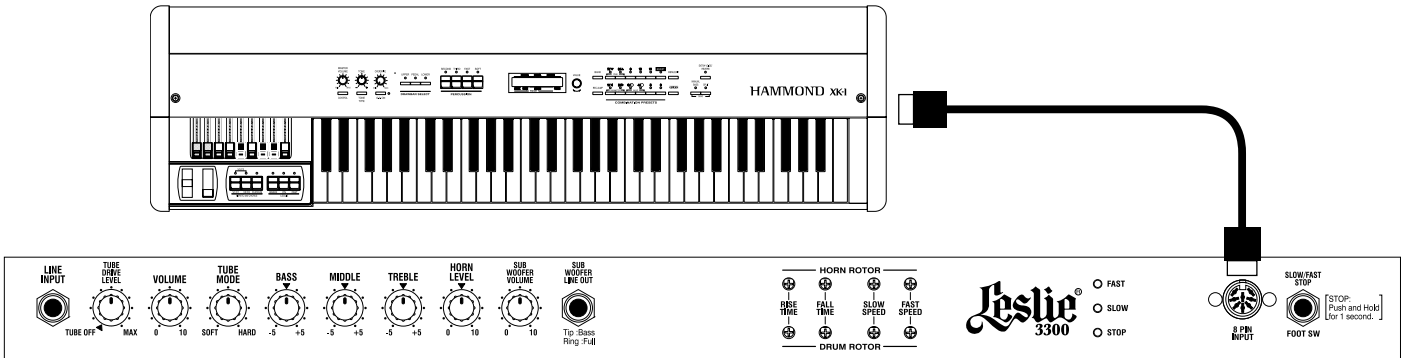

Steps:

1. Connect the optional Leslie 8-pin Cable (LC8-7M) as shown above.
2. Set the VOLUME control on the Leslie 3300 to the 3 position.
3. Turn the Power switch on the organ to the ON position.
4. Turn the Power switch on the Leslie 3300 to the ON position.
5. Switch the Leslie speed switch on the organ from Slow to Fast. The rotors in the Leslie 3300 should simultaneously change speeds from Slow to Fast and the Rotor Mode Indicator lights should switch from Slow to Fast.
6. While playing the organ at maximum volume, adjust the VOLUME setting on the Leslie for the desired volume level.

NOTE: The Remote mode does not function when the 8-Pin Cable is used.

◆ HOOK-UP WITHOUT ANY LESLIE CONNECTOR

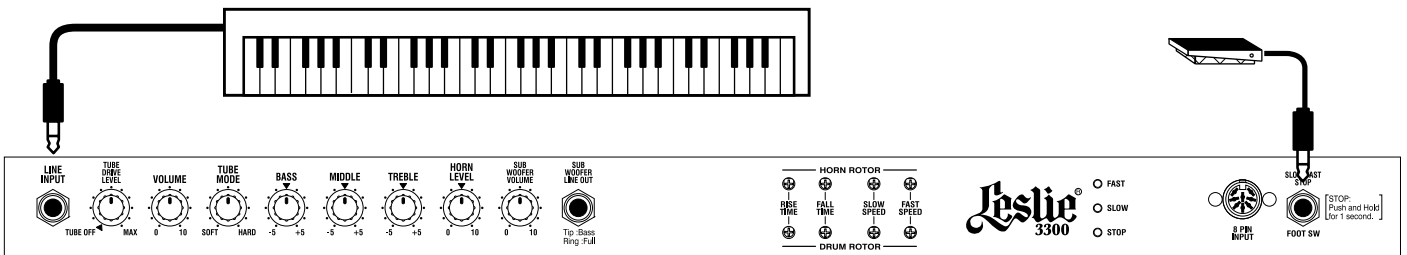

Steps:

1. Connect the LINE OUT from the Organ to the LINE INPUT Jack on the Leslie 3300 by means of a 1/4" phone cable (available at your local audio store).
2. Plug the FS-9H Foot Switch into the FOOT SW jack on the Leslie 3300.
3. Set the VOLUME control of the Leslie 3300 to the 3 position.
4. Switch ON the power of the Organ.
5. Switch ON the Power of the Leslie 3300.
6. The Rotor Mode Indicator lights of the Leslie 3300 should light and the rotors should start to turn.
7. Momentarily depress the Foot Switch and the Leslie should change speeds, either Slow to Fast or Fast to Slow speed. If you depress the Foot Switch for 1.5 seconds or more, the rotors in the Leslie will stop rotating.
8. While playing the organ at maximum volume, adjust the VOLUME setting on the Leslie for the desired volume level.

NOTE: If you have a built-in Leslie Simulator in your organ, turn in OFF when using the Leslie 3300. Refer to your organ's owners manual for reference if required.

◆ USING MULTIPLE LESLIE CONNECTORS SIMULTANEOUSLY

You can use the 11-pin, 8-pin and the LINE Inputs on your Leslie 3300 at the same time under the following conditions.

- The sounds from all the Inputs will be mixed.
- You can switch the speeds of the Leslie by either the organ connected to the 11-pin Leslie connector or the 8-pin Input. On the organ that you do not want to have the ability to change Leslie speeds, set the Leslie Switch to the Leslie OFF(OFF MODE = BREAK) or STOP position.
- You can also control the speeds of the rotor by the Foot Switch simultaneously with the Leslie switches on the organ that is setup to control the Leslie. The Foot Switch will have priority control over the Leslie switch on the organ.

◆ Controlling the Overdrive depth of the Leslie 3300 from an Organ. For this example we used an XK-3.

1. Set the MASTER VOLUME control on the XK-3 to the middle or center position and fully depress the Expression Pedal if one is connected.
2. Set the TUBE MODE control of the Leslie to the middle position and turn the TUBE DRIVE LEVEL control fully counterclockwise (TUBE OFF).

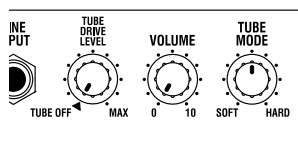

3. Set the VOLUME control on the Leslie at the position where you get your desired maximum volume without distortion.
4. While playing the organ, turn the TUBE DRIVE LEVEL control on the Leslie clockwise and set it at a point just before the distortion begins.
5. Set the MASTER VOLUME control on the XK-3 to the maximum position. Play the organ and make sure you hear some distortion. The Distortion will increase as you turn the TUBE MODE control on the Leslie clockwise.
6. While playing the organ you will discover that the depth of the Overdrive will change depending upon the position of the Expression Pedal.

You can achieve similar effects on other organ and keyboard products.

Try changing the location of the MASTER VOLUME control (step 1) on the XK-3 to find your favorite effect.

NOTE: Be careful not to have extremely deep overdrive. Depending on the position of the Expression Pedal, you may not be able to control the overdrive depth, and the organ sounds may always be distorted.

◆ How to effectively use the MIDDLE and TREBLE controls on the Leslie 3300

The frequency characteristics of the Horn Rotor are very similar to those found on other traditional Leslie like the model 122.

If you desire, you can flatten the frequency characteristics by setting the Middle control slightly less than the center position and the Treble control slightly more than the center position.

◆ Factory set positions for the Trimmer Controls

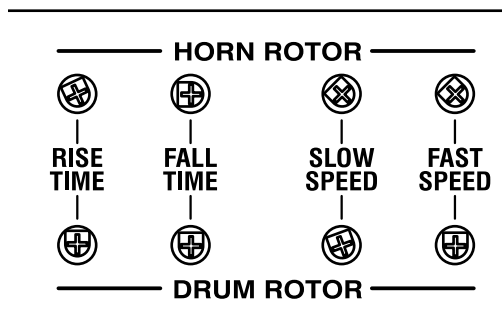

	RISE TIME	FALL TIME
HORN ROTOR	2 sec.	2.5 sec.
DRUM ROTOR	8 sec.	8 sec.

NOTE: The position of the Trimmer control may vary slightly from product to product.

The Trimmers are used to finely adjust the slow or fast speed of horn and drum and to set the rise and fall times to your personal liking. There is no “correct” speed, but the factory settings represent the setting that most players will like best. The trimmers have to be used with the correct size screwdriver and must be set with care. Once the trimmers are set to your personal liking it will not be necessary to adjust the trimmers all the time. It is always possible to return to the factory settings (see next page)

Resetting Rotation Speed to Factory Settings 11

To reset the rotation speed to the factory settings, perform the following procedure:

1

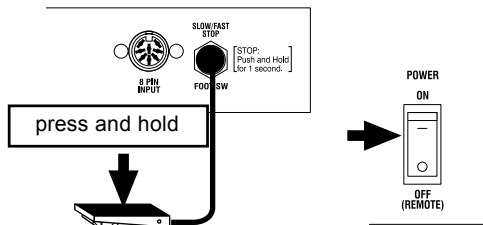

To start the adjusting program, plug the Foot Switch into the FOOT SW jack. Press and hold the Foot Switch while turning ON the power to the Leslie. Continue to hold this switch down until the STOP LED starts blinking to the speed of the rotor (about 4 seconds). You will be able to reset the speeds to the Factory settings by using the SLOW, FAST LEDs and the Trimmer controls. The Leslie will remain in the “adjusting program” mode until the power is turned OFF on the Leslie. If your organ is plugged into the 11-pin or 8-pin Leslie connector during this procedure, the organ’s Leslie switch will not function until this program is terminated.

2

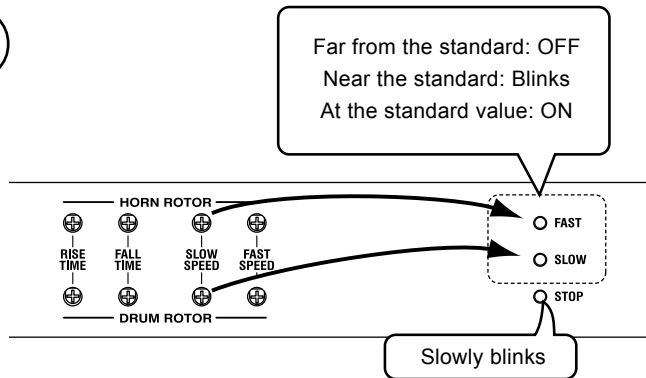

Slow speed adjustment.

While the STOP LED is slowly blinking, turn the SLOW SPEED Trimmer of the HORN and DRUM ROTOR and adjust the speed to the standard value.

When the speed of the Horn ROTOR comes to the standard value (about 40 rpm), the FAST LED turns on.

When the speed of the DRUM ROTOR comes to the standard value, the SLOW LED turns on.

Each LED is turned off if the speed is either slower or faster than standard, and it blinks faster as it nears the standard value.

3

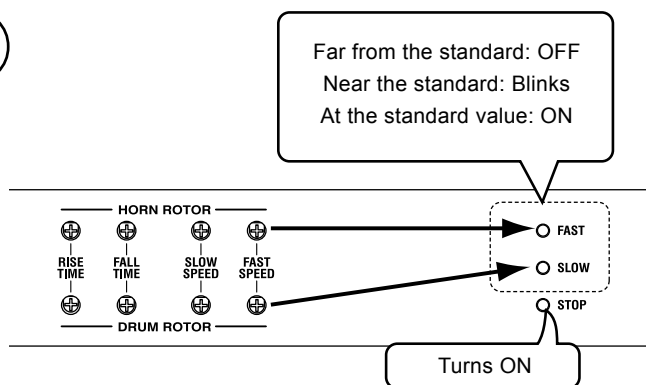

Fast speed adjustment.

Press and immediately release the Foot Switch while the rotating speed is SLOW. It takes about 10 seconds until it changes to the FAST mode, the speed becomes stable and the STOP LED turns on.

Turn the FAST SPEED Trimmer of the HORN and the DRUM ROTOR and adjust the speed to the standard value.

When the rotating speed of the HORN ROTOR comes to the standard value (about 400 rpm), the FAST LED turns on.

When the rotating speed of the DRUM ROTOR comes to the standard value, the SLOW LED turns on.

Each LED turns off when the rotating speed is either slower or faster than the standard, and it blinks when the value comes near the standard.

4

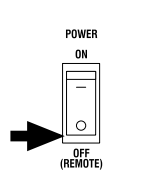

Turn OFF the Leslie’s Power. This completes the procedure.

Hammond maintains a policy of continuously improving and upgrading its instruments and therefore reserves the right to change specifications without notice. Although every attempt has been made to insure the accuracy of the descriptive contents of this Manual, total accuracy cannot be guaranteed.

Should the owner require further assistance, inquiries should first be made to your Authorized Hammond Dealer. If you still need further assistance, contact Hammond at the following addresses:

In the United States Contact:

HAMMOND SUZUKI USA, Inc.
733 Annoreno Dr.
Addison, IL 60101
UNITED STATES

In Europe contact:

HAMMOND SUZUKI EUROPE
B.V.
IR. D.S. Tuynmanweg 4A
4131 PN Vianen
THE NETHERLANDS

All other countries contact:

HAMMOND SUZUKI Ltd.
25-11, Ryoke 2 Chome
Naka-ku, Hamamatsu
430-0852 (Shizuoka)
JAPAN

Website:
www.hammondorganco.com

E-mail: Info@hammondsuzuki.com
Website:
www.hammondsuzuki.com

Website:
www.suzuki-music.co.jp

Technical materials are available and can be obtained by mailing a request to the appropriate address listed above marked ATTENTION: SERVICE DEPARTMENT.

Manufacturer:
SUZUKI MUSICAL INSTRUMENT MFG. CO., Ltd.
25-12, Ryoke 2 Chome Naka-ku,
Hamamatsu 430-0852 (Shizuoka)
JAPAN